

Qty. Description

1 **Product name:** Adapter 6"R - PN 16



Note! Product picture may differ from actual product

Product No.: On request

Product No: On request

EAN number: On request

Materials:

Material: Stainless steel
EN 1.4308
AISI 304

Installation:

Maximum operating pressure: PN 16 bar

Type of connection: R
DIN

Pipework connection: DN 200

Size of connection: 6 inch

Flange standard: DIN EN 1092-1

Pressure rating for connection: PN 16

Adapter extension length: 195 mm

Others:

Gross weight: 16.5 kg

Shipping volume: 0.029 m³

Country of origin: CN

Custom tariff no.: 84139100

Description	Value
General information:	
Product name:	Adapter 6"R - PN 16
Product No:	On request
EAN number:	On request
Materials:	
Material:	Stainless steel
Material:	EN 1.4308
Material:	AISI 304
Installation:	
Maximum operating pressure:	PN 16 bar
Type of connection:	R
Type of connection:	DIN
Pipework connection:	DN 200
Size of connection:	6 inch
Flange standard:	DIN EN 1092-1
Pressure rating for connection:	PN 16
Adapter extension length:	195 mm
Others:	
Gross weight:	16.5 kg
Shipping volume:	0.029 m ³
Country of origin:	CN
Custom tariff no.:	84139100

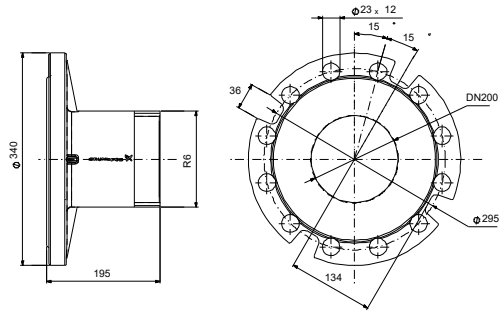

On request Adapter 6"R - PN 16

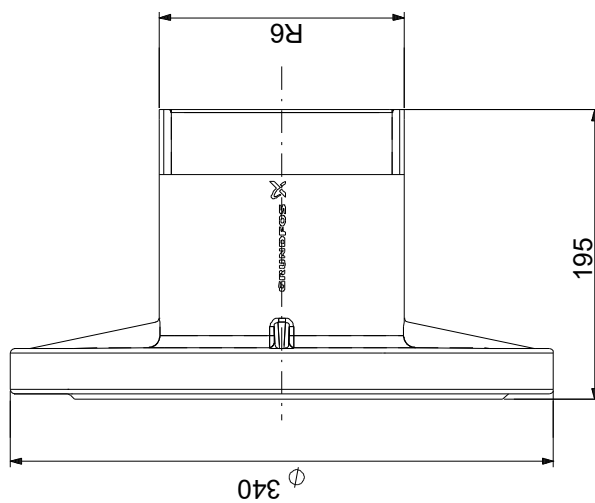
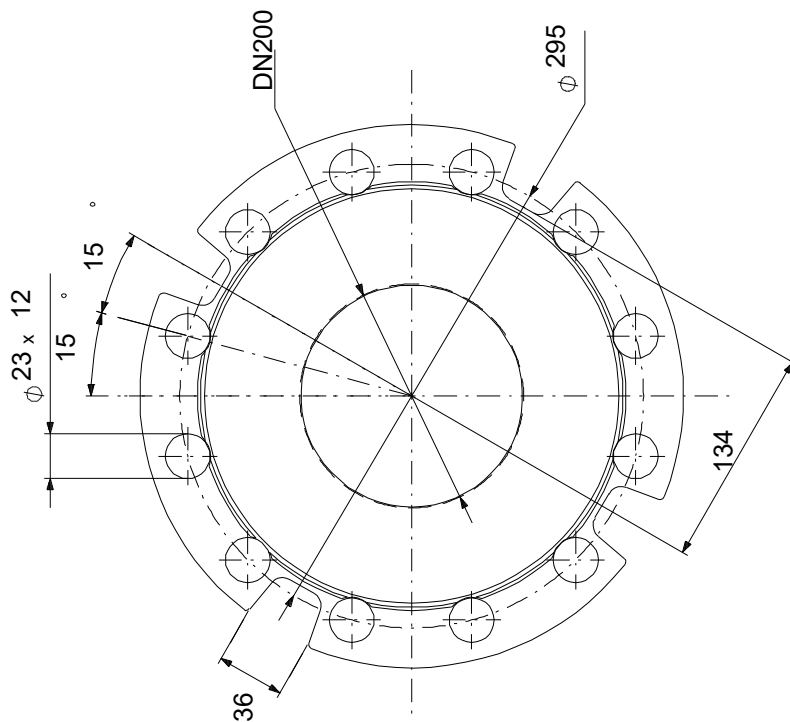

Note! All units are in [mm] unless others are stated.
Disclaimer: This simplified dimensional drawing does not show all details.

