

# Vorgabedaten

PROJEKT:	UNIT TAG:	MENGE:
ANSPRECHPARTNER: _____	SERVICELEISTUNG:	DATUM: _____
INGENIEUR/TECHNIKER:	VORGEGEBEN VON:	DATUM:
AUFTRAGNEHMER:	BESTELLNUMMER:	DATUM:

## Hydro MPC-S 3 CRI 15-7

Druckerhöhungsanlagen mit EIN/AUS-Steuerung



Hinweis! Abbildung kann vom Produkt abweichen.

Servicebedingungen		Pumpendaten		Motordaten	
Fördermedium:	Wasser	Max. Betriebsdruck:	16 bar	Netzfrequenz:	50 Hz
Temperatur:	20 °C	Medientemperaturbereich:	5 .. 60 °C	Schutzart:	IP54
Relative Dichte:	1.000	Maximale Umgebungstemperatur:	40 °C		
		Produktnummer:	auf Anfr.		

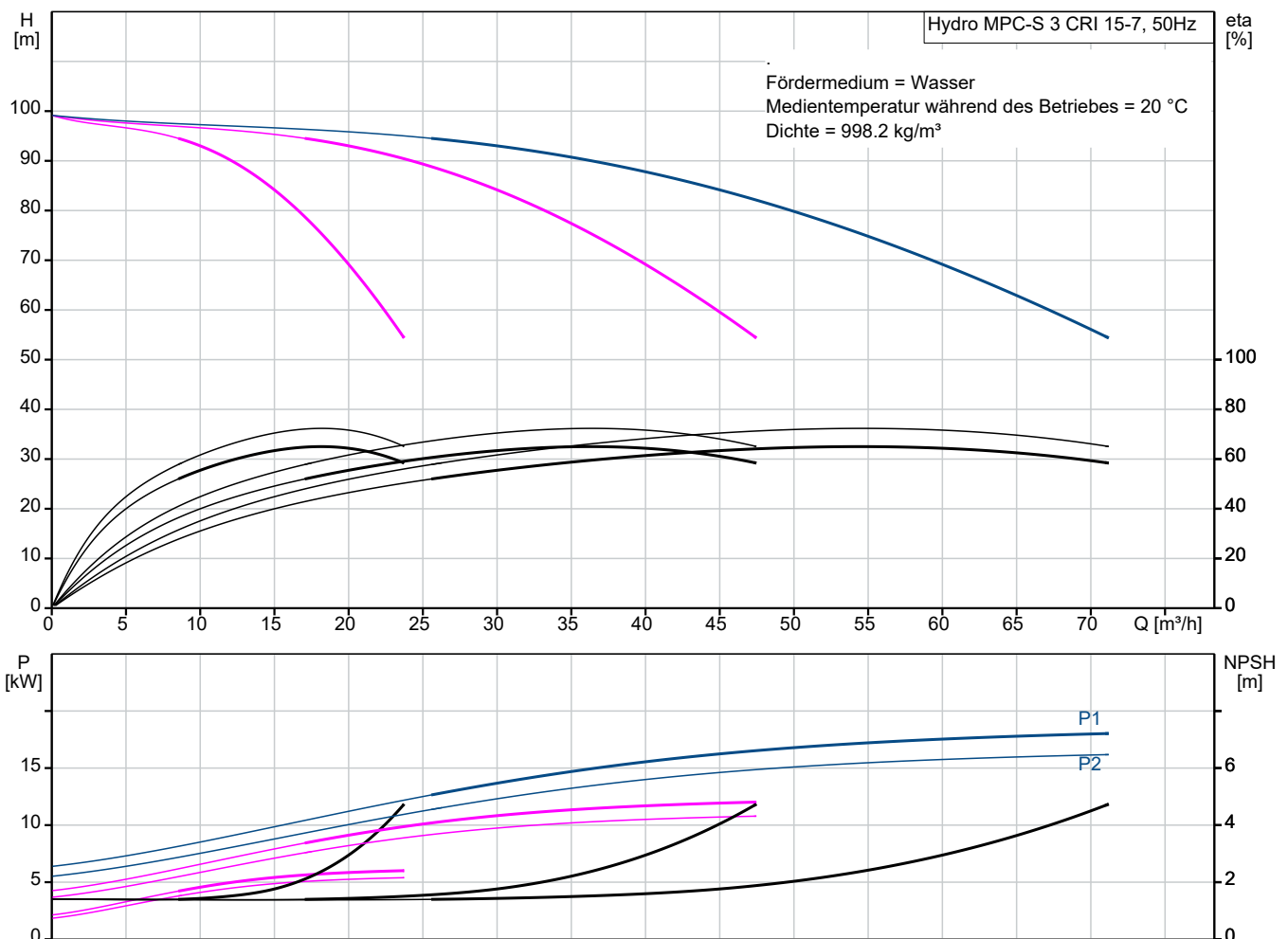

# Vorgabedaten

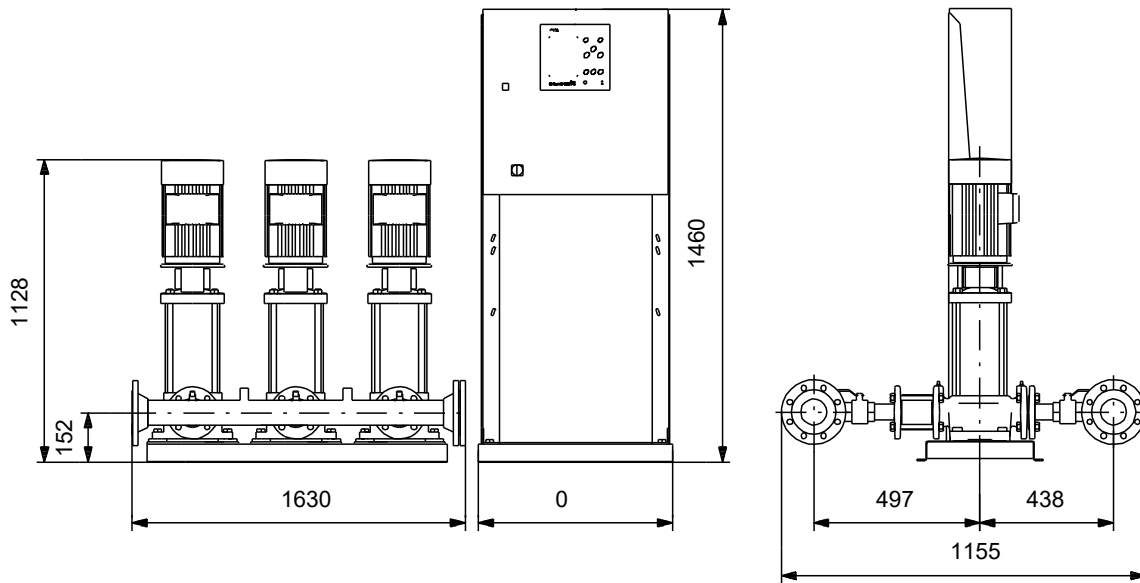

## Werkstoffe:

Verrohrung: Edelstahl 1.4571 (AISI 316 Ti)

**Anz. Beschreibung****1 Hydro MPC-S 3 CRI 15-7**

Hinweis! Abbildung kann vom Produkt abweichen.

Produktnr.: auf Anfr.

Pressure booster system supplied as compact assembly according to DIN standard 1988/T5.

The pumps are all mains-operated CR(I) pumps.

- \* Hydro MPC-S maintains the pressure through cutting in/out the CR(I) pumps.
- \* The system performance is adapted to the demand through cutting in/out the required number of CR(I) pumps and through parallel control of the pumps in operation.
- \* Pump changeover is automatic and depends on load, time and fault.

The system consists of these parts:

- \* vertical multistage centrifugal pumps, type CRI 15-7.
- \* The pumps are mains-operated (start/stop).
- \* Pump parts in contact with the pumped liquid are made of stainless steel EN DIN 1.4301.
- \* Pump bases and heads are of either cast iron/stainless steel (CRI) or cast iron EN-GJS-500-7 (CR), depending on pump type; other vital parts are made of stainless steel EN DIN 1.4301.
- \* The pumps are equipped with the service-friendly cartridge shaft seal HQQE (SiC/SiC/EPDM).
- \* Two manifolds of stainless steel EN DIN 1.4571.
- \* Base frame of stainless steel EN DIN 1.4301 up to CR 64. Above CR 64 the pumps are placed on a galvanized C-profile frame.
- \* One non-return valve (POM) and two isolating valves for each pump.
- \* Non-return valves are certified according to DVGW, isolating valves according to DIN and DVGW.
- \* Adapter with isolating valve for connection of diaphragm tank.
- \* Pressure gauge and pressure transmitter (analog output 4-20 mA).
- \* Control MPC in a steel cabinet, IP 54, including main switch, all required fuses, motor protection, switching equipment and microprocessor-controlled CU 352.

Dry-running protection and diaphragm tank are available according to the list of accessories.

Pump operation is controlled by Control MPC with the following functions:

- \* Mains-operated pumps(start/stop).
- \* Constant Pressure – the system is able to maintain an almost constant pressure through cutting in/out the required number of pumps.
- \* System overview – Nice system overview via pump animation and icons on color screen.
- \* Dry-running protection – increase your system reliability and decrease maintenance costs.
- \* Alarm & Warnings – real time alarms and warnings on the color display reduces downtime.
- \* Alarm & Warnings logger – storage of up to 24 alarms and warnings makes fault analyzing easier.
- \* Monitoring – the CU 352 holds several monitoring possibilities such as pressure level, pump outside duty range, this gives you great system insights.
- \* Logged data – valuable insights available on the big color screen or exported to a PC for further analysis.
- \* Protective functions – Several functions ensure reliable and safe operation and the result is longer lifetime.
- \* Clock program – setpoint automatically reduced to the required value at any given time which means money saved on energy.
- \* Redundancy – it is possible to assign one or more standby pumps, these will take over in case of failure.
- \*

**Anz. Beschreibung**

- |   |   |
|---|---|
| 1 | <p>Pump test run – prevents pumps from seizing up and liquid from decaying in the pumps and removes trapped air.</p> <ul style="list-style-type: none"><li>* Emergency run – pumps keep running regardless of warnings and alarms.</li><li>* Forced pump changeover – setting of pump changeover so the pumps run for the same number of operation hours.</li><li>* Fall back sensor - If the Primary sensor fails, the system will automatically be regulating on the fallback sensor at a predefined setpoint, thereby you avoiding downtime in case of primary sensor fault.</li><li>* Communication – Ethernet, PLC via IO 351, Modbus-Profibus-LON-GSM-GPRS via CIU modules.</li><li>* Multi language - wide range of operating languages.</li></ul> |
|---|---|

Pumps, piping, cabling complete as well as Control MPC are mounted on the base frame.  
The booster system has been preset and tested.

Fördermedium:	Wasser
zul. Mediumtemp.:	5 °C .. 60 °C
Max. Betriebsdruck:	16 bar
Max. Förderstrom d. Anlage:	70.5 m <sup>3</sup> /h
Nennstrom der Anlage:	33.1 A
Motorbemessungsleistung:	5.5 kW

Membranbehälter, Komponenten zur Wassermangelüberwachung und alternative Bedieneinheiten können aus der Zubehörliste ausgewählt werden.

Nettogewicht:	395 kg
---------------	--------

## auf Anfr. Hydro MPC-S 3 CRI 15-7 50 Hz

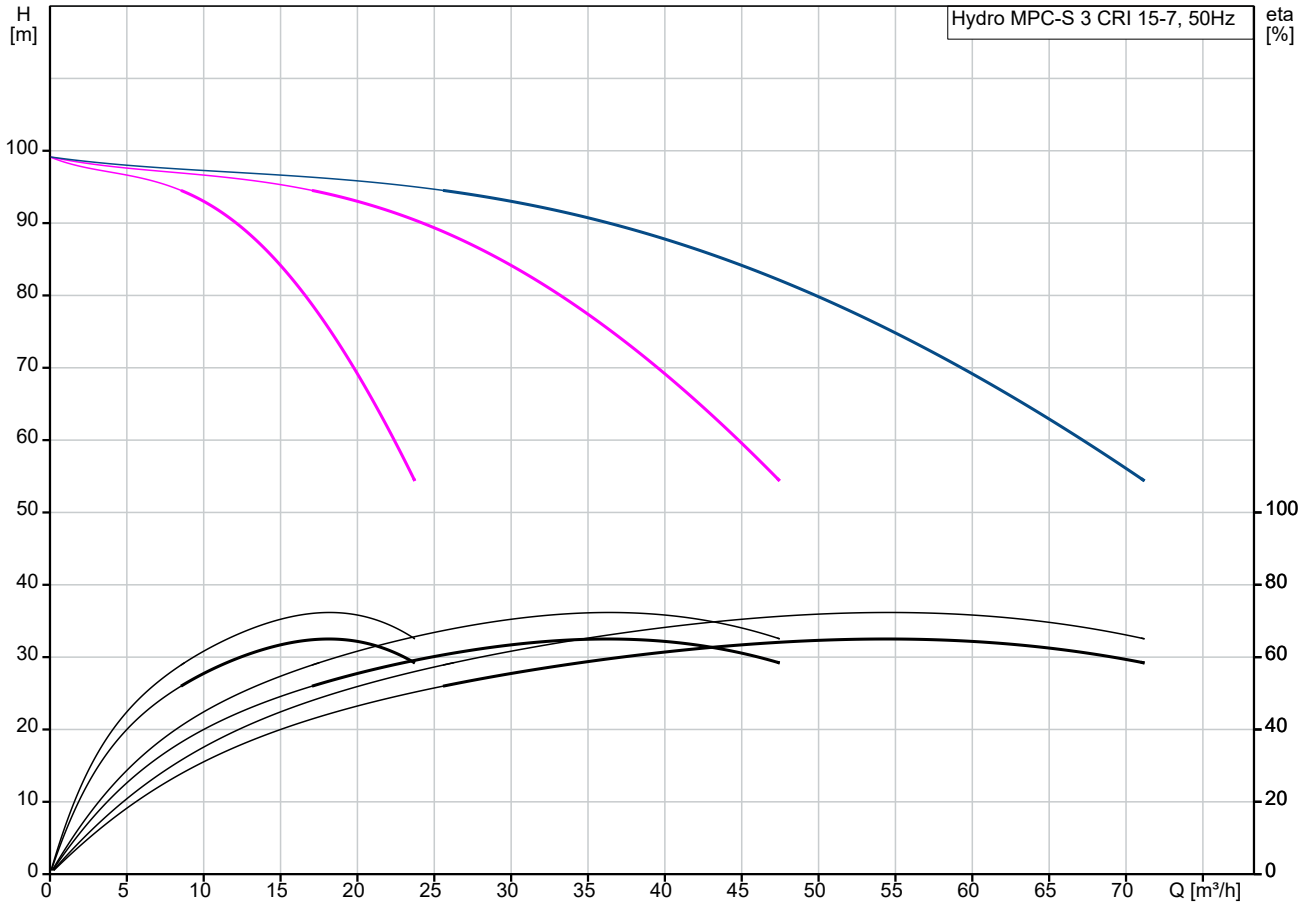

Fördermedium = Wasser  
Medientemperatur während des Betriebes = 20 °C  
Dichte = 998.2 kg/m³

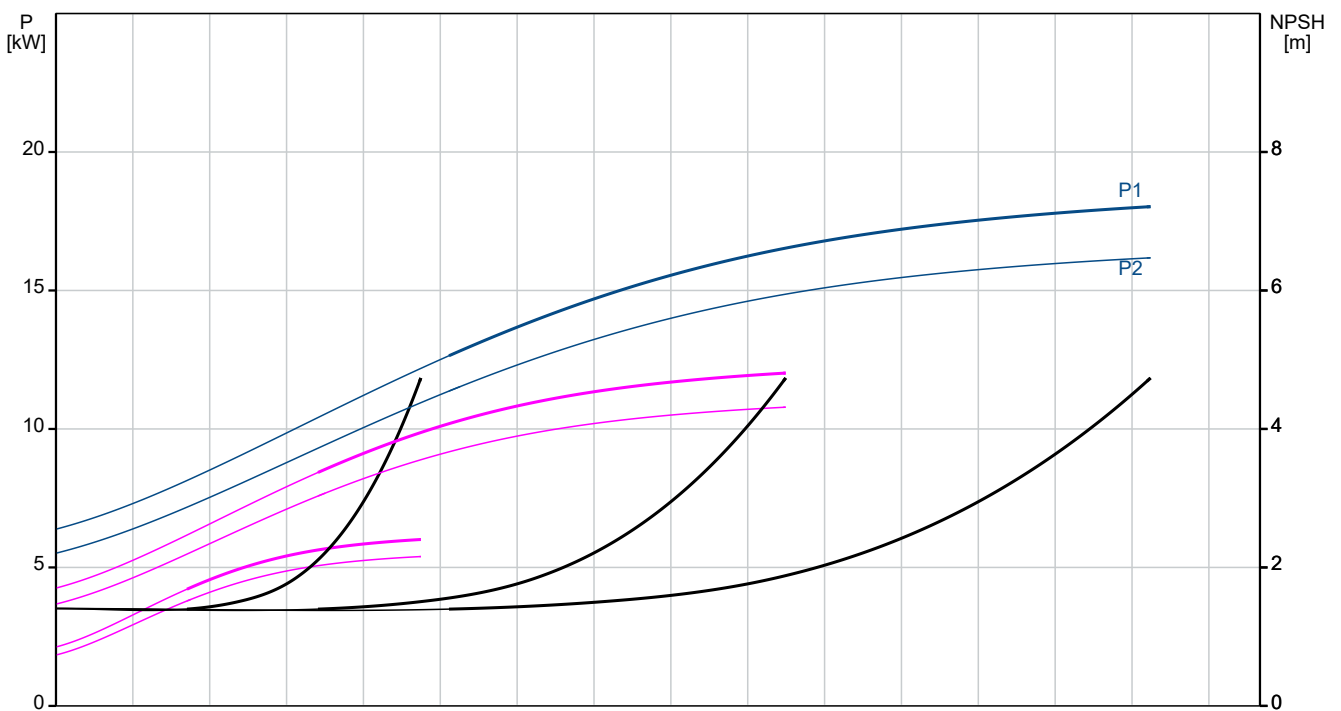

Beschreibung	Daten
--------------	-------

**Allgemeine Informationen:**

Produktbezeichnung:	Hydro MPC-S 3 CRI 15-7
Produktnummer:	auf Anfr.
EAN-Nummer:	auf Anfr.

**Technische Daten:**

Nennförderstrom:	51 m³/h
Maximaler Förderstrom:	70.5 m³/h
Nennförderhöhe:	77.9 m
Maximale Förderhöhe:	98.5 m
Bezeichnung der Hauptpumpe:	CRI 15-7
Produktnummer Hauptpumpe:	96501916
Anzahl der Pumpen:	3
Rückflußverhinderer:	Y

**Werkstoffe:**

Verrohrung:	Edelstahl 1.4571 (AISI 316 Ti)
-------------	--------------------------------

**Installation:**

Umgebungstemperatur:	5 .. 40 °C
Max. Betriebsdruck:	16 bar
Maximal zulässiger Zulaufdruck:	6.2 bar
Anschluss Saugseite:	DN100
Anschluss Druckseite:	DN100
Nennndruck:	PN 16
Masseanschluss:	PE
Anlagengestaltung:	A

**Fördermedium:**

Fördermedium:	Wasser
Medientemperaturbereich:	5 .. 60 °C
Medientemperatur während des Betriebs:	20 °C

Dichte:	998.2 kg/m³
---------	-------------

**Elektrische Daten:**

Leistung (P2) je Pumpe:	5.5 kW
Netzfrequenz:	50 Hz
Bemessungsspannung:	3 x 380-415 V
Nennstrom der Anlage:	33.1 A
Einschaltart:	DOL
Schutzart (gemäß IEC 34-5):	IP54
Funkentstörung:	EMC DIRECTIVE(2014/30/EU)

Anzahl der Phasen der Hauptpumpe:	3
-----------------------------------	---

**Art der Steuerung:**

Steuerungsart:	S
----------------	---

**Behälter:**

Membrandruckbehälter:	N
-----------------------	---

**Sonstiges:**

Basisprodukt:	Y
Nettogewicht:	395 kg
Bruttogewicht:	447 kg
Softwareversion:	98272227
Konfigurationsdatei Control MPC:	98272008
Konfigurationsdatei Hydro MPC:	98272018

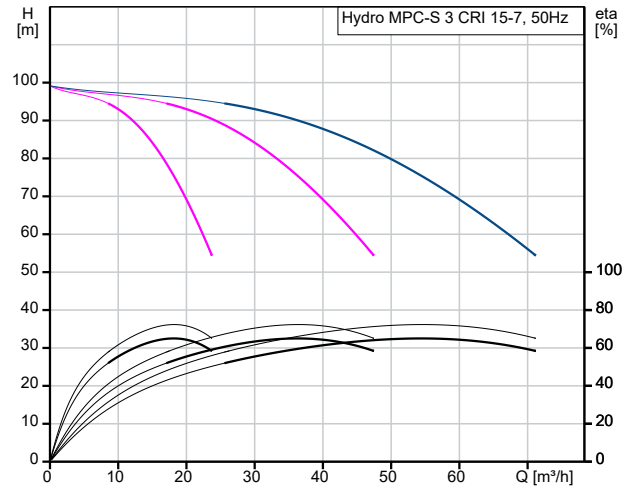

Fördermedium = Wasser  
 Medientemperatur während des Betriebes = 20 °C  
 Dichte = 998.2 kg/m³

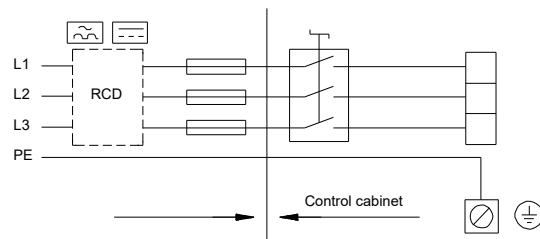
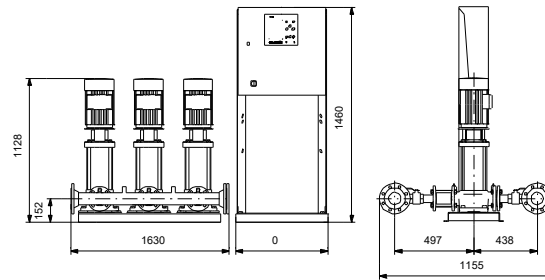
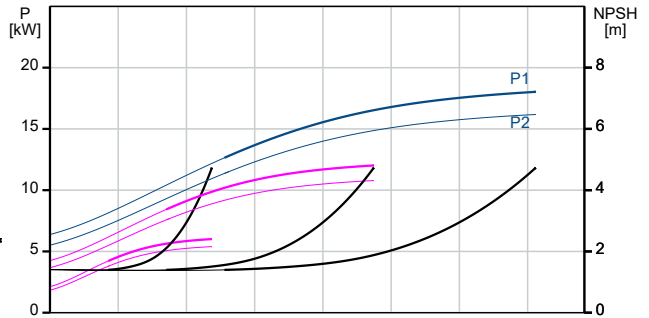

## auf Anfr. Hydro MPC-S 3 CRI 15-7 50 Hz

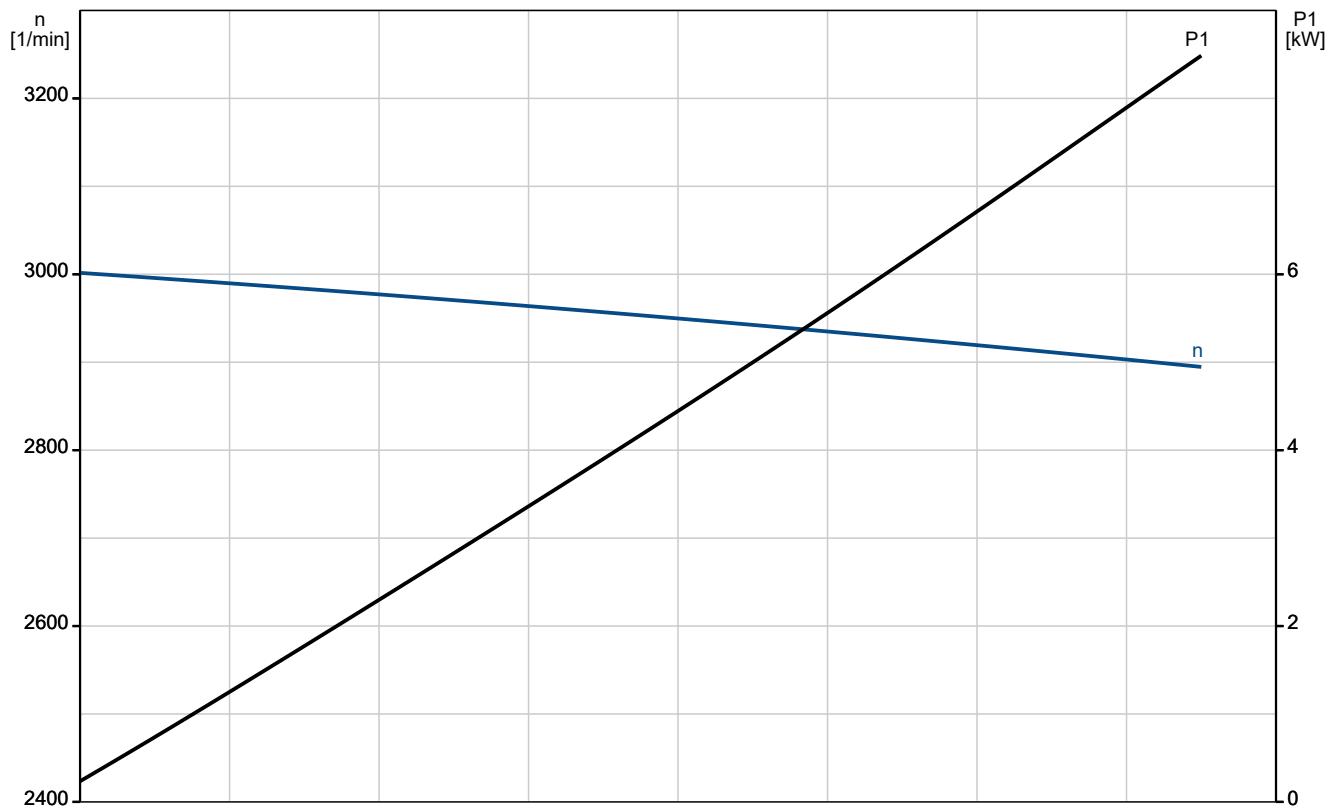
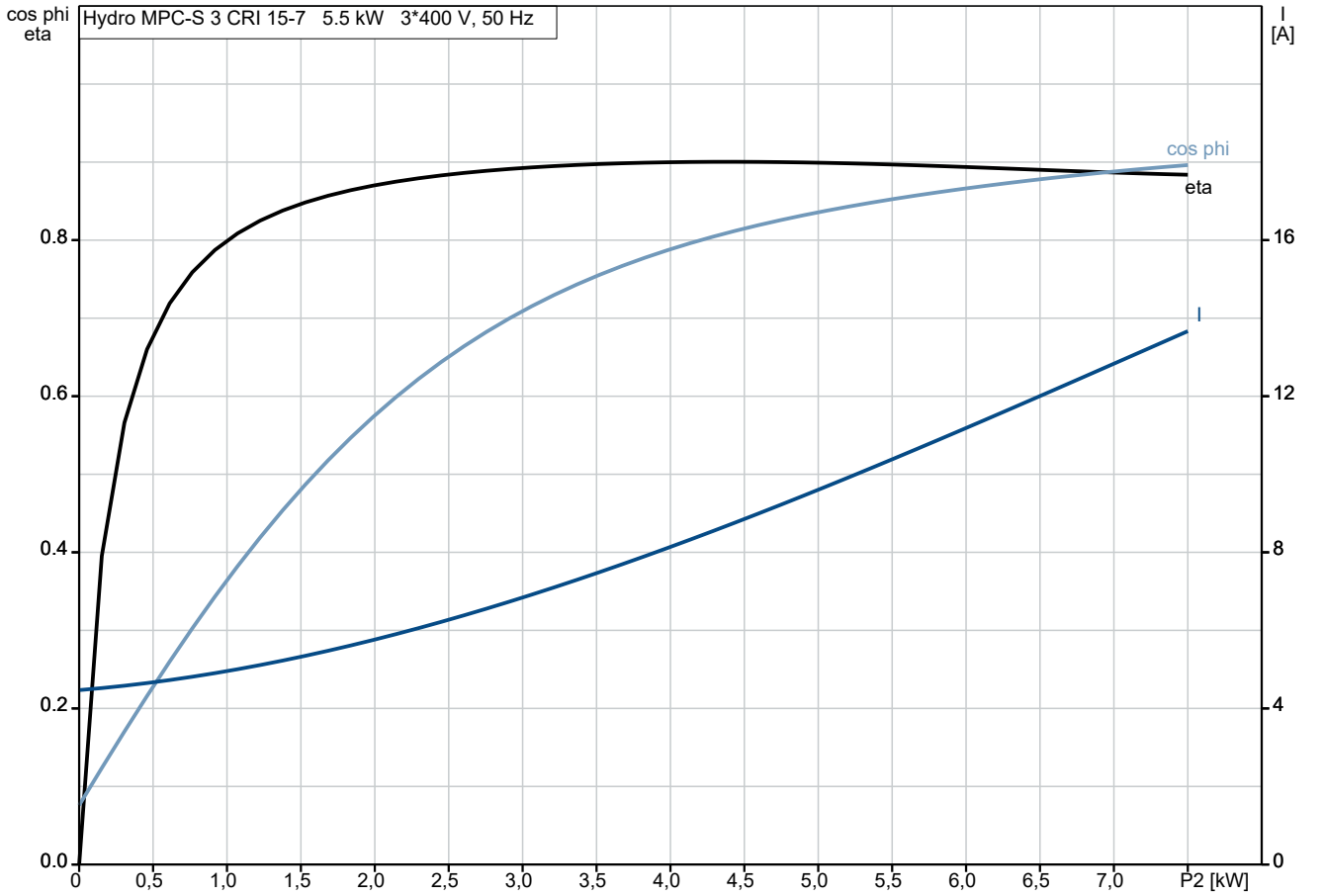

## auf Anfr. Hydro MPC-S 3 CRI 15-7 50 Hz

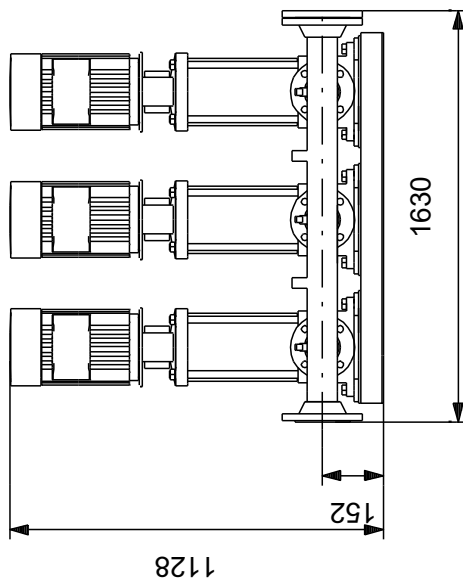
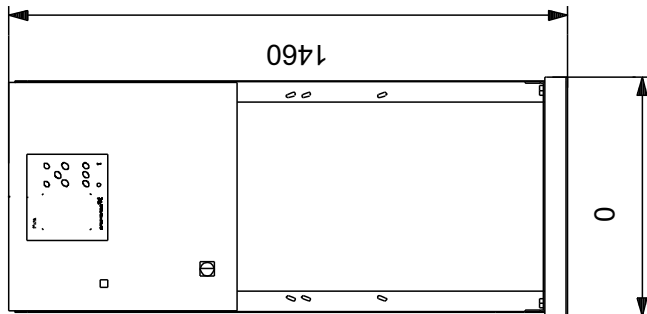
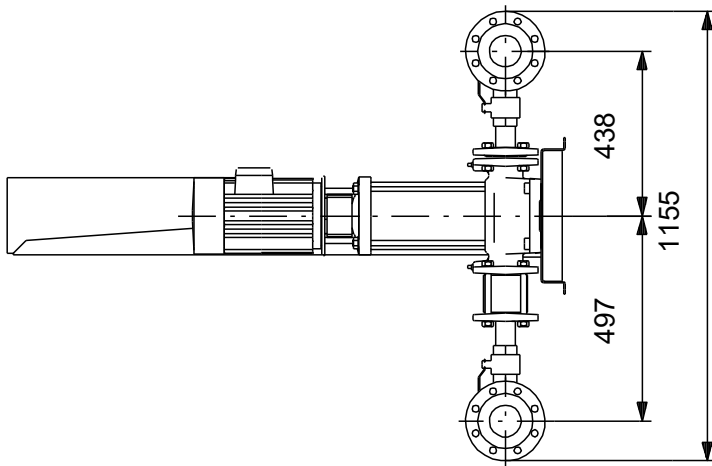

Achtung! Soweit nicht anders angegeben, handelt es sich um Millimeterangaben (mm). Die vereinfachte Maßzeichnung zeigt nicht alle

## auf Anfr. Hydro MPC-S 3 CRI 15-7 50 Hz

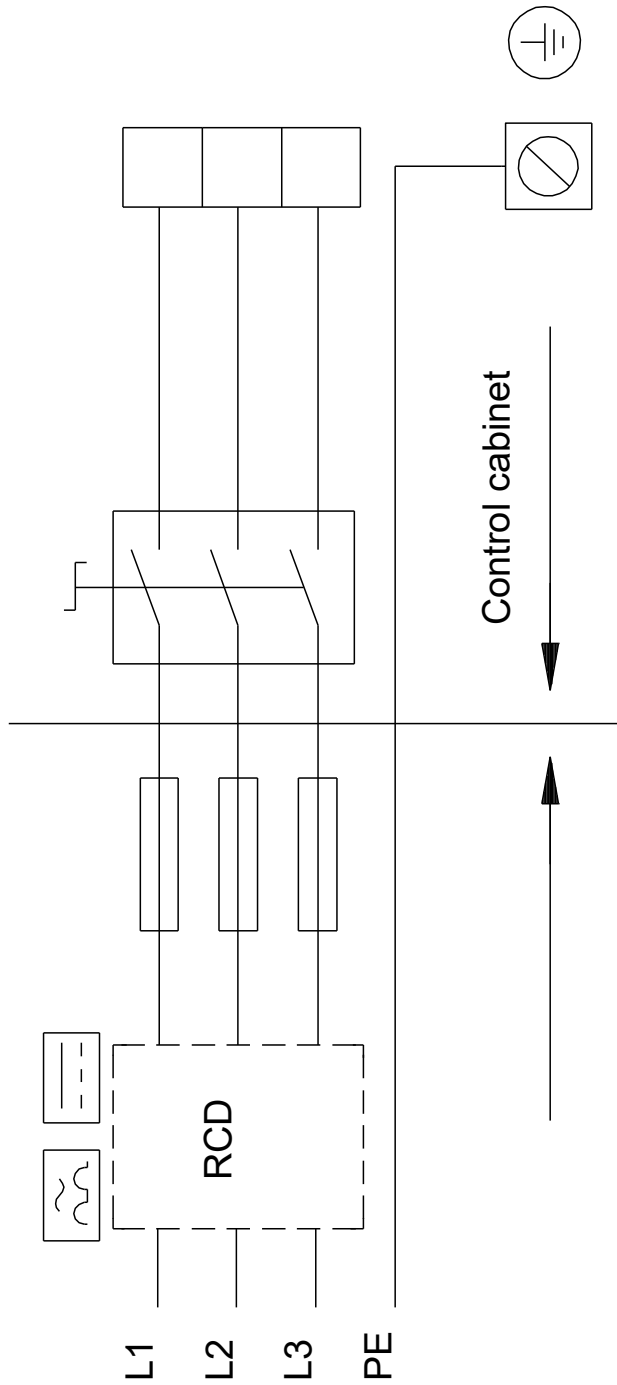

Hinweis: Alle Einheiten in [mm] soweit nicht anders bezeichnet.

