

Vorgabedaten

PROJEKT:	UNIT TAG:	MENGE:
ANSPRECHPARTNER: _____	SERVICELEISTUNG:	DATUM: _____
INGENIEUR/TECHNIKER:	VORGEGEBEN VON:	DATUM:
AUFTRAGNEHMER:	BESTELLNUMMER:	DATUM:

Hydro MPC-S 5 CR 32-4

Druckerhöhungsanlagen mit EIN/AUS-Steuerung



Hinweis! Abbildung kann vom Produkt abweichen.

Servicebedingungen		Pumpendaten		Motordaten	
Fördermedium:	Wasser	Max. Betriebsdruck:	16 bar	Netzfrequenz:	50 Hz
Temperatur:	20 °C	Medientemperaturbereich:	5 .. 60 °C	Schutzart:	IP54
Relative Dichte:	1.000	Maximale Umgebungstemperatur:	40 °C		
		Produktnummer:	auf Anfr.		

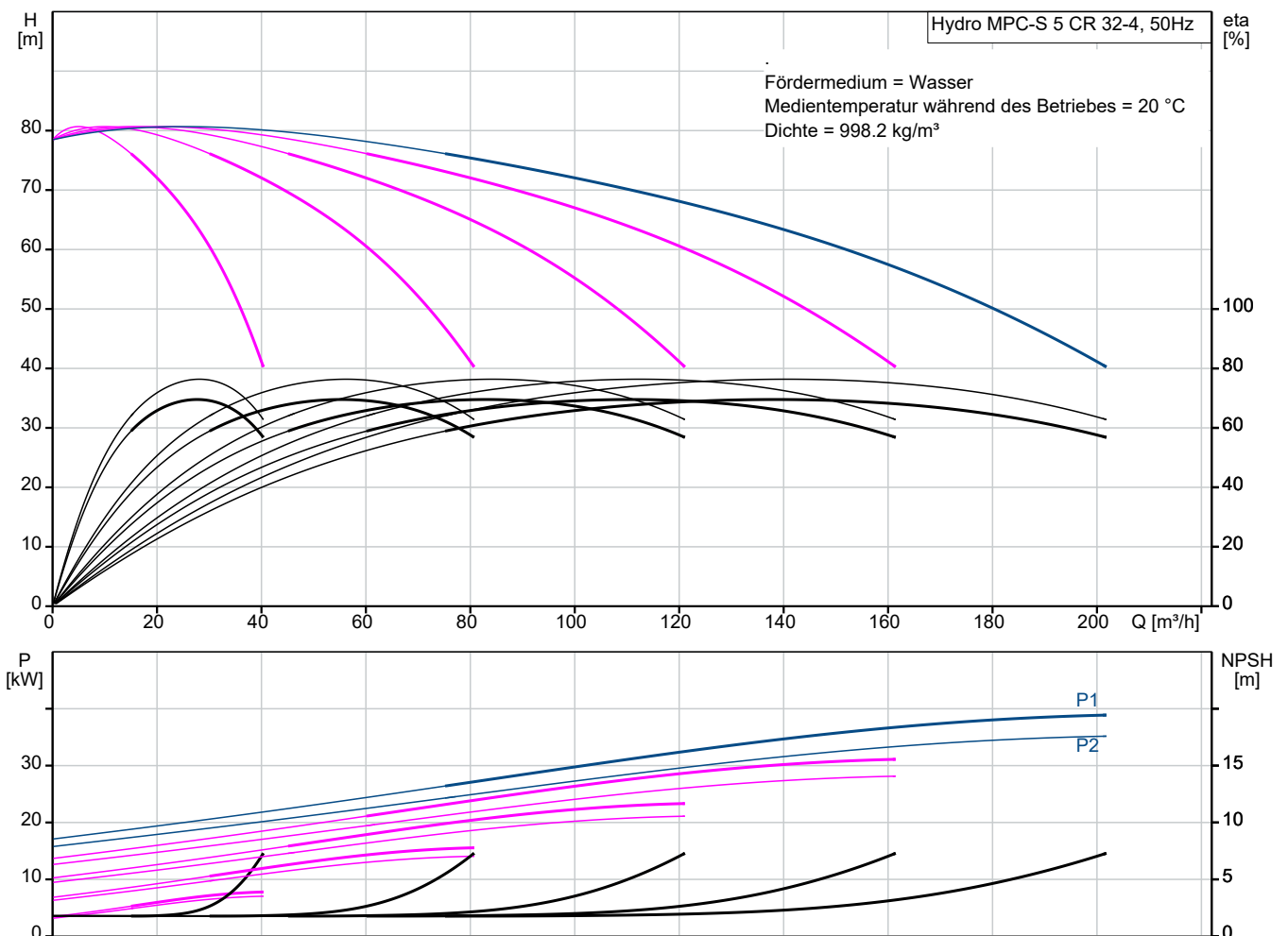

Vorgabedaten

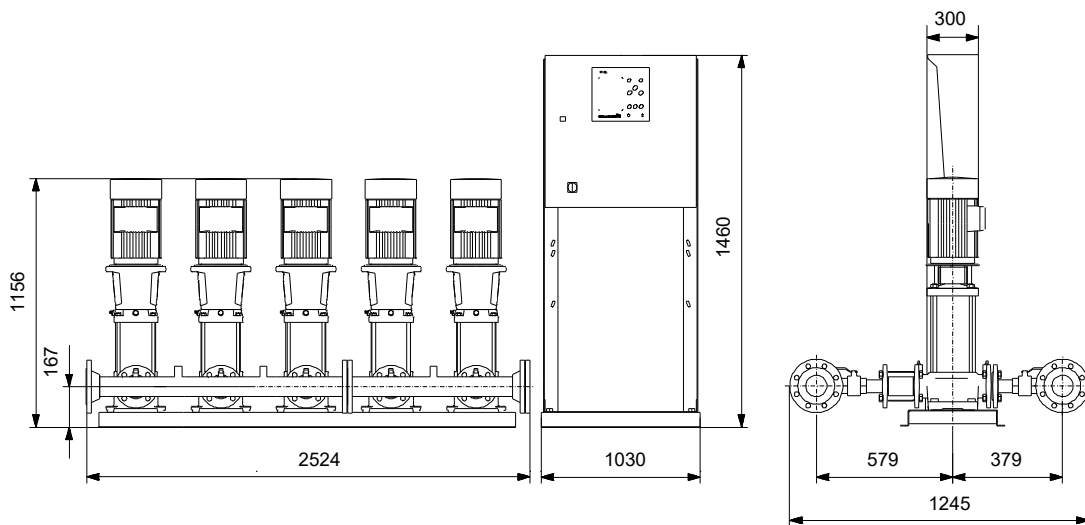

Werkstoffe:

Verrohrung: Edelstahl 1.4571 (AISI 316 Ti)

Anz. Beschreibung1 **Hydro MPC-S 5 CR 32-4**

Hinweis! Abbildung kann vom Produkt abweichen.

Produktnr.: auf Anfr.

Pressure booster system supplied as compact assembly according to DIN standard 1988/T5.

The pumps are all mains-operated CR(I) pumps.

- * Hydro MPC-S maintains the pressure through cutting in/out the CR(I) pumps.
- * The system performance is adapted to the demand through cutting in/out the required number of CR(I) pumps and through parallel control of the pumps in operation.
- * Pump changeover is automatic and depends on load, time and fault.

The system consists of these parts:

- * vertical multistage centrifugal pumps, type CR 32-4.
- * The pumps are mains-operated (start/stop).
- * Pump parts in contact with the pumped liquid are made of stainless steel EN DIN 1.4301.
- * Pump bases and heads are of either cast iron/stainless steel (CRI) or cast iron EN-GJS-500-7 (CR), depending on pump type; other vital parts are made of stainless steel EN DIN 1.4301.
- * The pumps are equipped with the service-friendly cartridge shaft seal HQQE (SiC/SiC/EPDM).
- * Two manifolds of stainless steel EN DIN 1.4571.
- * Base frame of stainless steel EN DIN 1.4301 up to CR 64. Above CR 64 the pumps are placed on a galvanized C-profile frame.
- * One non-return valve (POM) and two isolating valves for each pump.
- * Non-return valves are certified according to DVGW, isolating valves according to DIN and DVGW.
- * Adapter with isolating valve for connection of diaphragm tank.
- * Pressure gauge and pressure transmitter (analog output 4-20 mA).
- * Control MPC in a steel cabinet, IP 54, including main switch, all required fuses, motor protection, switching equipment and microprocessor-controlled CU 352.

Dry-running protection and diaphragm tank are available according to the list of accessories.

Pump operation is controlled by Control MPC with the following functions:

- * Mains-operated pumps(start/stop).
- * Constant Pressure – the system is able to maintain an almost constant pressure through cutting in/out the required number of pumps.
- * System overview – Nice system overview via pump animation and icons on color screen.
- * Dry-running protection – increase your system reliability and decrease maintenance costs.
- * Alarm & Warnings – real time alarms and warnings on the color display reduces downtime.
- * Alarm & Warnings logger – storage of up to 24 alarms and warnings makes fault analyzing easier.
- * Monitoring – the CU 352 holds several monitoring possibilities such as pressure level, pump outside duty range, this gives you great system insights.
- * Logged data – valuable insights available on the big color screen or exported to a PC for further analysis.
- * Protective functions – Several functions ensure reliable and safe operation and the result is longer lifetime.
- * Clock program – setpoint automatically reduced to the required value at any given time which means money saved on energy.
- * Redundancy – it is possible to assign one or more standby pumps, these will take over in case of failure.
- *

Anz. Beschreibung

- | | |
|---|-----------------------------------------------------------------------------------------------------------------------------------------------------------------------------------------------------------------------------------------------------------------------------------------------------------------------------------------------------------------------------------------------------------------------------------------------------------------------------------------------------------------------------------------------------------------------------------------------------------------------------------------------------------------------------------------------------------------------------------------------------------|
| 1 | <p>Pump test run – prevents pumps from seizing up and liquid from decaying in the pumps and removes trapped air.</p> <ul style="list-style-type: none">* Emergency run – pumps keep running regardless of warnings and alarms.* Forced pump changeover – setting of pump changeover so the pumps run for the same number of operation hours.* Fall back sensor - If the Primary sensor fails, the system will automatically be regulating on the fallback sensor at a predefined setpoint, thereby you avoiding downtime in case of primary sensor fault.* Communication – Ethernet, PLC via IO 351, Modbus-Profibus-LON-GSM-GPRS via CIU modules.* Multi language - wide range of operating languages. |
|---|-----------------------------------------------------------------------------------------------------------------------------------------------------------------------------------------------------------------------------------------------------------------------------------------------------------------------------------------------------------------------------------------------------------------------------------------------------------------------------------------------------------------------------------------------------------------------------------------------------------------------------------------------------------------------------------------------------------------------------------------------------------|

Pumps, piping, cabling complete as well as Control MPC are mounted on the base frame.
The booster system has been preset and tested.

Fördermedium:	Wasser
zul. Mediumtemp.:	5 °C .. 60 °C
Max. Betriebsdruck:	16 bar
Max. Förderstrom d. Anlage:	200 m³/h
Nennstrom der Anlage:	71.2 A
Motorbemessungsleistung:	7.5 kW

Membranbehälter, Komponenten zur Wassermangelüberwachung und alternative Bedieneinheiten können aus der Zubehörliste ausgewählt werden.

Nettogewicht:	849 kg
---------------	--------

auf Anfr. Hydro MPC-S 5 CR 32-4 50 Hz

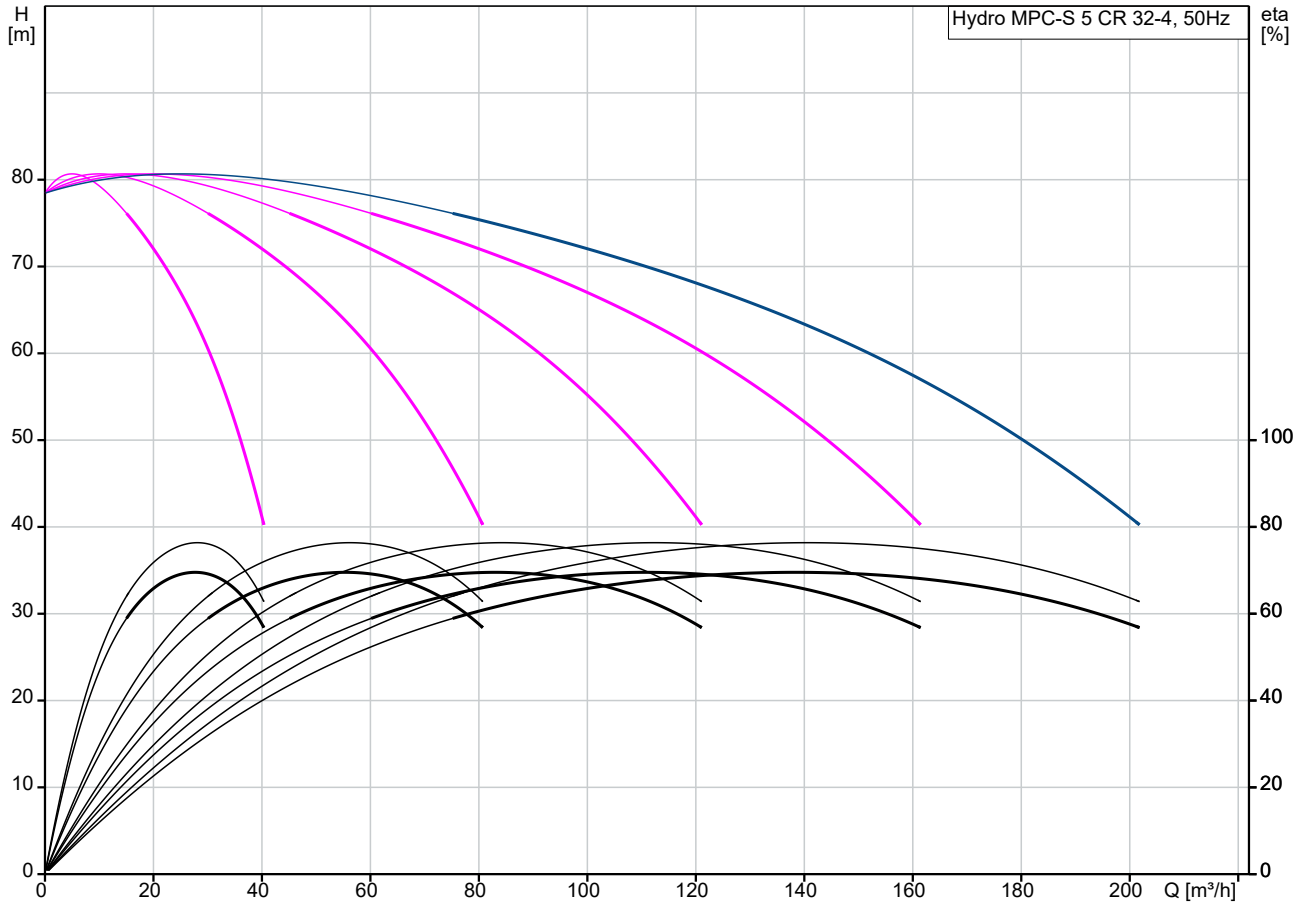

Fördermedium = Wasser
 Medientemperatur während des Betriebes = 20 °C
 Dichte = 998.2 kg/m³

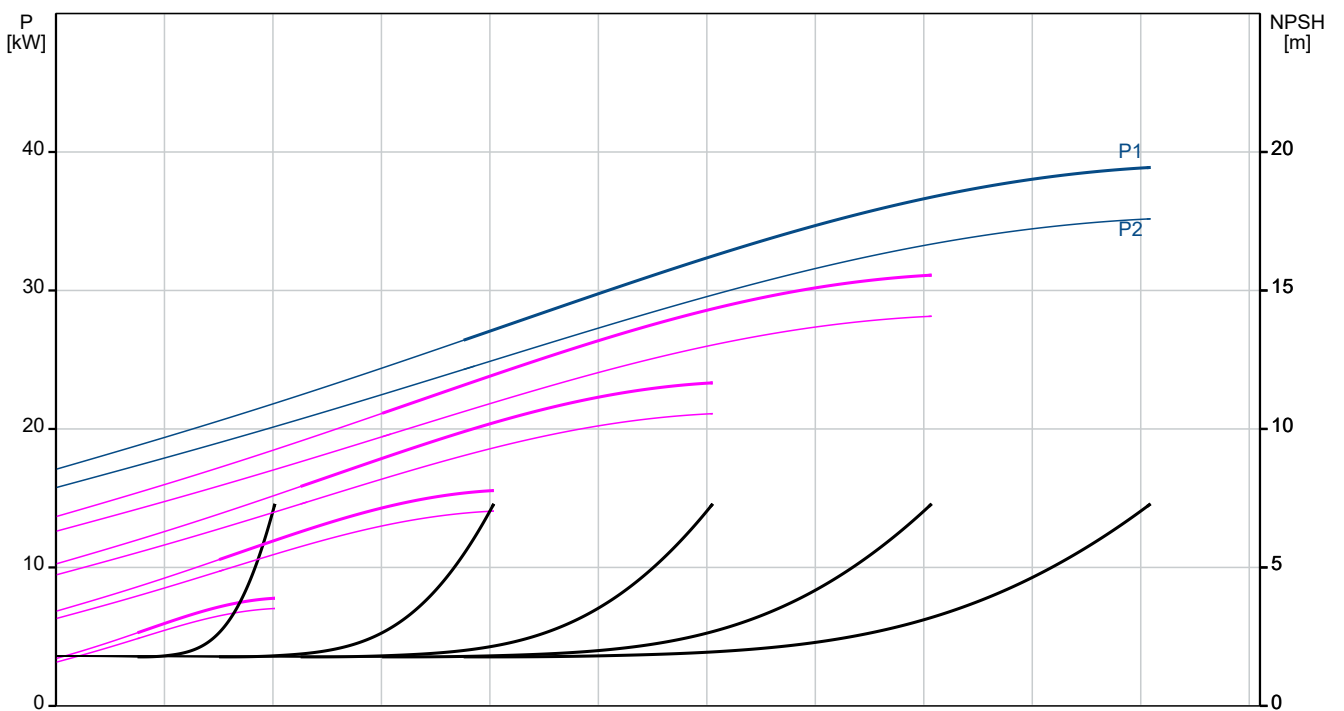

Beschreibung	Daten
Allgemeine Informationen:	
Produktbezeichnung:	Hydro MPC-S 5 CR 32-4
Produktnummer:	auf Anfr.
EAN-Nummer:	auf Anfr.
Technische Daten:	
Nennförderstrom:	150 m³/h
Maximaler Förderstrom:	200 m³/h
Nennförderhöhe:	59.1 m
Maximale Förderhöhe:	77.8 m
Bezeichnung der Hauptpumpe:	CR 32-4
Produktnummer Hauptpumpe:	96122013
Anzahl der Pumpen:	5
Rückflußverhinderer:	Y
Werkstoffe:	
Verrohrung:	Edelstahl 1.4571 (AISI 316 Ti)
Installation:	
Umgebungstemperatur:	5 .. 40 °C
Max. Betriebsdruck:	16 bar
Maximal zulässiger Zulaufdruck:	8.2 bar
Anschluss Saugseite:	DN150
Anschluss Druckseite:	DN150
Nennndruck:	PN 16
Masseanschluss:	PE
Anlagengestaltung:	D
Fördermedium:	
Fördermedium:	Wasser
Medientemperaturbereich:	5 .. 60 °C
Medientemperatur während des Betriebs:	20 °C
Dichte:	998.2 kg/m³
Elektrische Daten:	
Leistung (P2) je Pumpe:	7.5 kW
Netzfrequenz:	50 Hz
Bemessungsspannung:	3 x 380-415 V
Nennstrom der Anlage:	71.2 A
Einschaltart:	S/D
Schutzart (gemäß IEC 34-5):	IP54
Funkentstörung:	EMC DIRECTIVE(2014/30/EU)
Anzahl der Phasen der Hauptpumpe:	3
Art der Steuerung:	
Steuerungsart:	S
Behälter:	
Membrandruckbehälter:	N
Sonstiges:	
Basisprodukt:	Y
Nettogewicht:	849 kg
Bruttogewicht:	940 kg
Softwareversion:	98272162
Konfigurationsdatei Control MPC:	98272010
Konfigurationsdatei Hydro MPC:	98272018

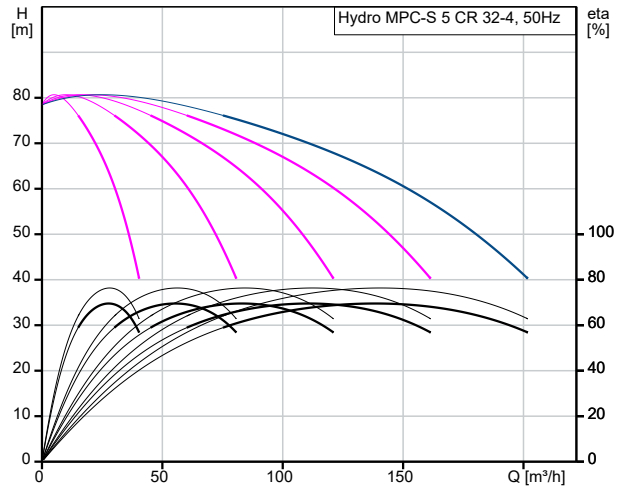

Fördermedium = Wasser
 Medientemperatur während des Betriebes = 20 °C
 Dichte = 998.2 kg/m³

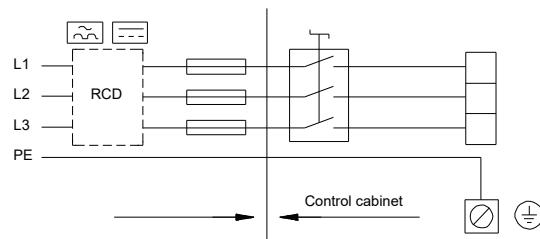
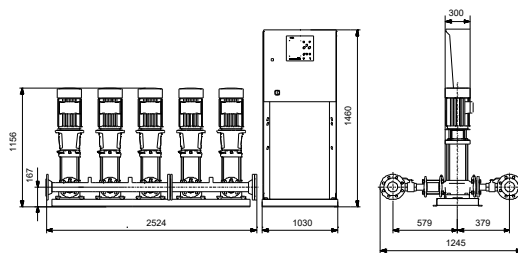
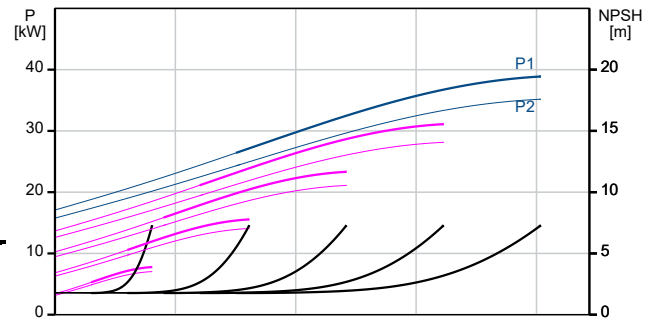

auf Anfr. Hydro MPC-S 5 CR 32-4 50 Hz

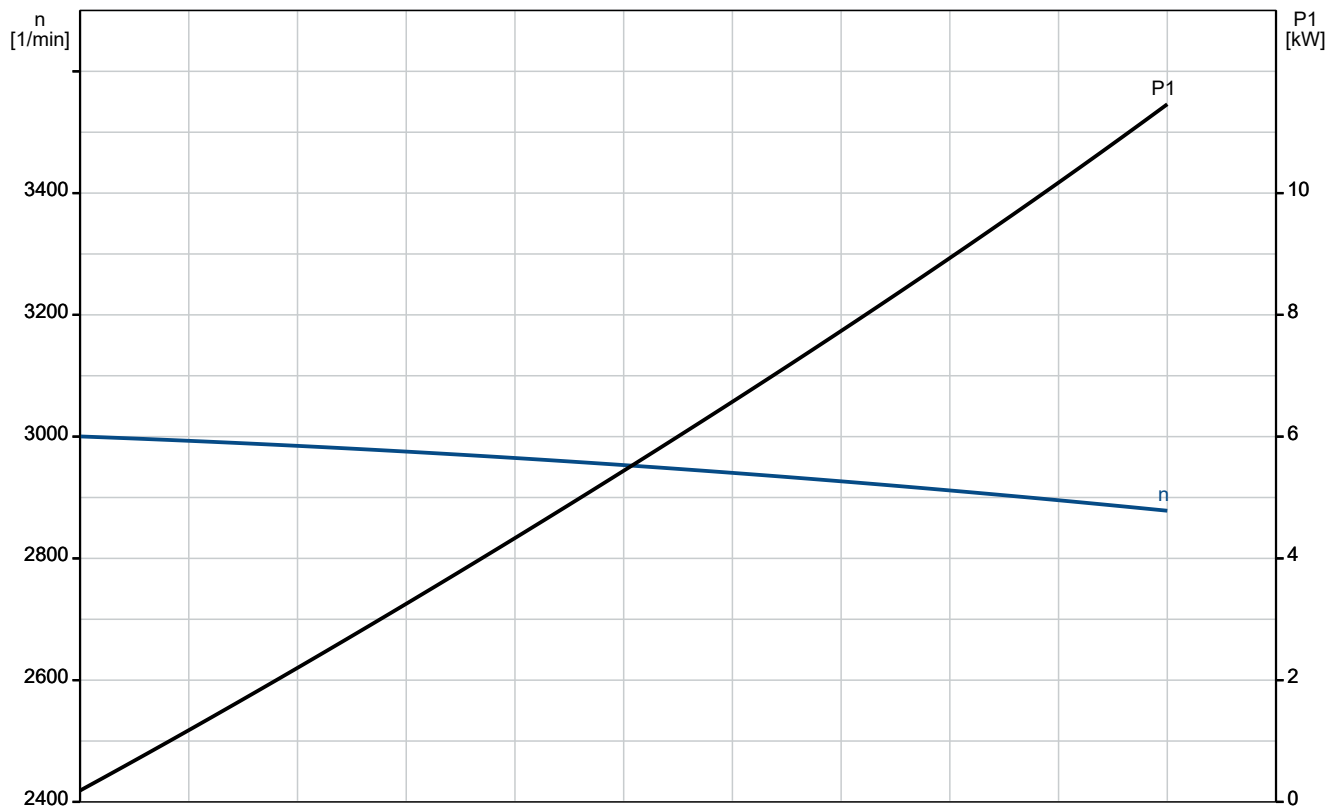
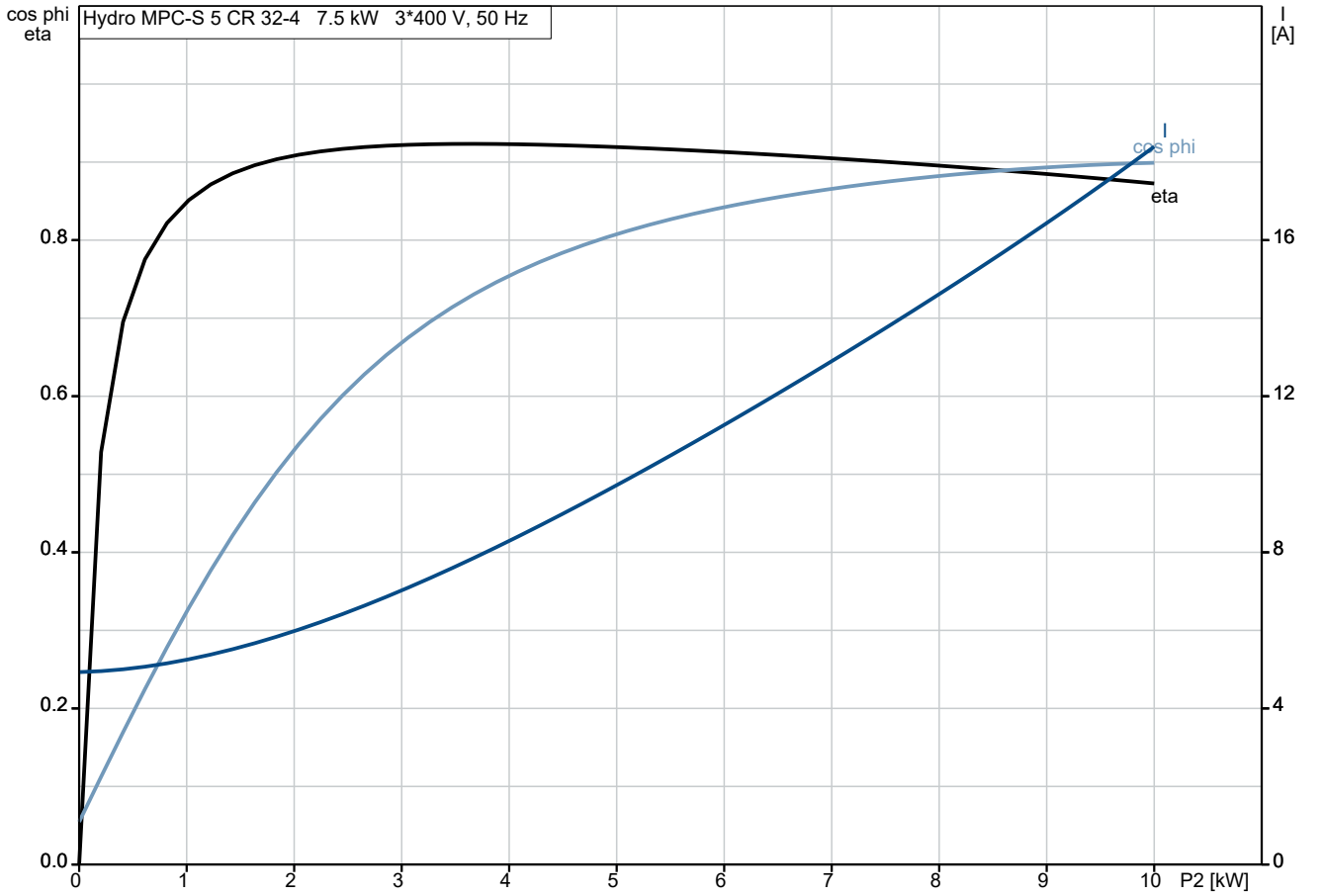

auf Anfr. Hydro MPC-S 5 CR 32-4 50 Hz

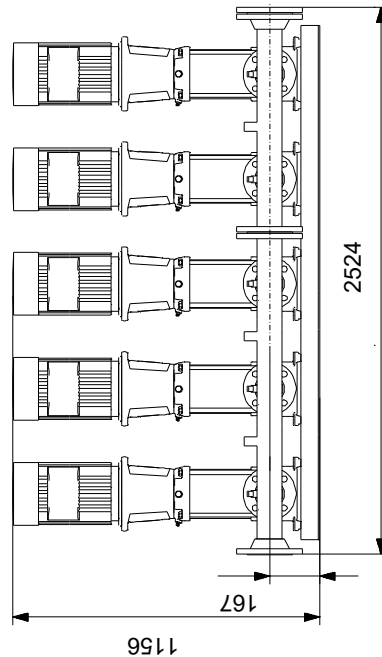
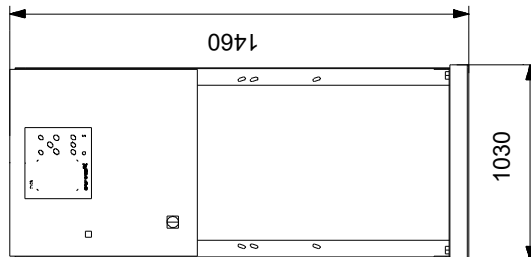
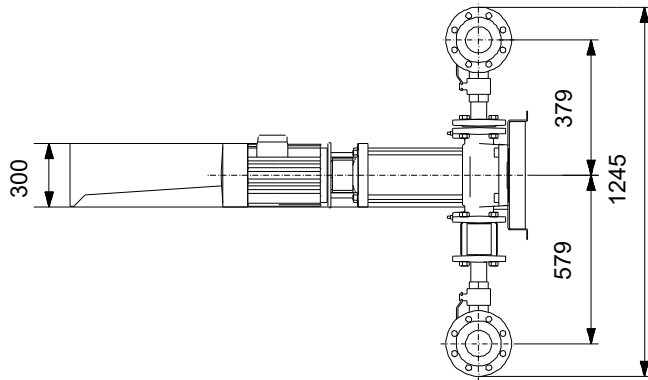

Achtung! Soweit nicht anders angegeben, handelt es sich um Millimeterangaben (mm). Die vereinfachte Maßzeichnung zeigt nicht alle

auf Anfr. Hydro MPC-S 5 CR 32-4 50 Hz



Hinweis: Alle Einheiten in [mm] soweit nicht anders bezeichnet.

