

Qty. Description

1 NKE 80-250/234 AIA1F2AESBQGEUW1



Note! Product picture may differ from actual product

Product No.: On request

Non-self-priming, single-stage, centrifugal pump designed according to ISO 5199 with dimensions and rated performance according to EN 733. Flanges are PN 16 with dimensions according to EN 1092-2. The pump has an axial suction port, a radial discharge port and horizontal shaft. It is of the back pull-out design enabling removal of the motor, coupling, bearing bracket and impeller without disturbing the pump housing or pipework.

The unbalanced rubber bellows seal is according to DIN EN 12756.

The pump is fitted with a foot-mounted, fan-cooled asynchronous motor. Pump and motor are mounted on a common base frame.

The product's minimum efficiency index (MEI) is greater or equal to 0.70. This is by the Commission Regulation (EU) considered as an indicative benchmark for best-performing water pump available on the market as from 1 January 2013.

Pump and motor are mounted on a common steel base frame in accordance with ISO 3661. The back pull-out design makes it possible to service the pump when the pump housing is still connected to the inlet and discharge pipes.

- 1) Remove the bolts in the bearing bracket support foot and motor foot.
- 2) Remove the bearing bracket and the motor from the pump housing.

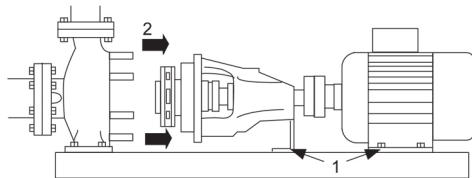

Pump

The pump is fitted with an unbalanced rubber bellows seal with torque transmission across the spring and around the bellows. Due to the bellows, the seal does not wear the shaft, and the axial movement is not prevented by deposits on the shaft.



Seal faces:

- Rotating seal ring material: silicon carbide (SiC)
- Stationary seat material: silicon carbide (SiC)

This material pairing is used where higher corrosion resistance is required. The high hardness of this material pairing offers good resistance against abrasive particles.

Secondary seal material: EPDM (ethylene-propylene rubber)

EPDM has excellent resistance to hot water. EPDM is not suitable for mineral oils.

The shaft is made of stainless steel and has a diameter of 32 mm where the coupling is mounted.

The pump uses a standard coupling between the pump and motor shaft.

Qty. Description

1

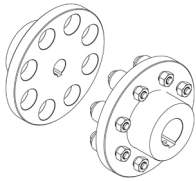

The language on the pump nameplate is English.

The base frame is prepared for grouting. Grouting improves the contact of the base frame with the foundation and stiffens the base frame construction. This changes the vibration level.

Grouting is mandatory for all base frame types for all 2-pole pumps equal to and above 55 kW to fulfill the max vibration level requirements stated in standards. For other pump motor combinations grouting of the base frame is optional.

Motor

The motor is a totally enclosed, fan-cooled motor with principal dimensions to IEC and DIN standards. Electrical tolerances comply with IEC 60034.

The motor efficiency is classified as IE4 in accordance with IEC 60034-30-1.

The motor has thermistors (PTC sensors) in the windings in accordance with DIN 44081/DIN 44082. The protection reacts to both slow- and quick-rising temperatures, e.g. constant overload and stalled conditions.

Thermal switches must be connected to an external control circuit in a way which ensures that the automatic reset cannot cause accidents. The motors must be connected to a motor-protective circuit breaker according to local regulations.

The motor requires no external motor protection. The motor control unit incorporates protection against slow- and quick-rising temperatures, e.g. constant overload and stalled conditions.

Further product details

Cast-iron parts have an epoxy-based coating made in a cathodic electro-deposition (CED) process. CED is a high-quality dip-painting process where an electrical field around the products ensures deposition of paint particles as a thin, well-controlled layer on the surface.

Technical data

Controls:

VFD product number: 99616826
 Frequency converter: Built-in
 Type of frequency converter: CUE 3X380-500V IP55 RUG 55KW
 Appr. for VFD: CE, CULUS, C-TICK
 Pressure sensor: N

Liquid:

Pumped liquid: Water
 Liquid temperature range: -25 .. 120 °C
 Selected liquid temperature: 20 °C
 Density: 998.2 kg/m³

Technical:

Pump speed on which pump data are based: 2978 rpm
 Rated flow: 203.6 m³/h
 Pump with motor (Yes/No): Y
 Rated head: 69.07 m
 Actual impeller diameter: 234 mm
 Nominal impeller diameter: 250
 Code for shaft seal: BQQE
 Mechanical seal type: Single
 Curve tolerance: ISO9906:2012 3B
 Bearing design: Standard

Qty.	Description
1	<p>Materials:</p> <p>Pump housing: Cast iron EN-GJL-250 ASTM class 35</p> <p>Wear ring: Brass</p> <p>Impeller: Cast iron EN-GJL-200 ASTM class 30</p> <p>Internal pump house coating: CED</p> <p>Shaft: Stainless steel EN 1.4301 AISI 304</p> <p>Installation:</p> <p>Range of ambient temperature: -10 .. 50 °C</p> <p>Maximum operating pressure: 16 bar</p> <p>Pipe connection standard: EN 1092-2</p> <p>Type of inlet connection: DIN</p> <p>Type of outlet connection: DIN</p> <p>Size of inlet connection: DN 100</p> <p>Size of outlet connection: DN 80</p> <p>Pressure rating for connection: PN 16</p> <p>Coupling type: Flexible w/o spacer</p> <p>Base frame design: EN/ISO</p> <p>Code for base frame: 9C ST</p> <p>Grouting (Yes/No): Y</p> <p>Electrical data:</p> <p>Motor type: SIEMENS</p> <p>Rated power - P2: 55 kW</p> <p>Mains frequency: 50 Hz</p> <p>Rated voltage: 3 x 380-420D/660-725Y V</p> <p>Rated current: 95/55 A</p> <p>Starting current: 750 %</p> <p>Cos phi - power factor: 0.88</p> <p>Rated speed: 2978 rpm</p> <p>IE efficiency: IE4 95,3%</p> <p>IE Efficiency class: IE4</p> <p>Motor efficiency at full load: 95.3 %</p> <p>Motor efficiency at 3/4 load: 95.2 %</p> <p>Motor efficiency at 1/2 load: 94.5 %</p> <p>Number of poles: 2</p> <p>Enclosure class (IEC 34-5): IP55</p> <p>Insulation class (IEC 85): F</p> <p>Motor No: 92779445</p> <p>Bearing insulation type N-end: COATED RING</p> <p>Others:</p> <p>Minimum efficiency index, MEI ≥: 0.70</p> <p>Net weight: 771 kg</p> <p>Gross weight: 927 kg</p> <p>Shipping volume: 3.09 m³</p> <p>Country of origin: HU</p> <p>Custom tariff no.: 84137059</p> <p>Language on pump nameplate: GB</p>

On request NKE 80-250/234 AIA1F2AESBQQEUW1 50 Hz

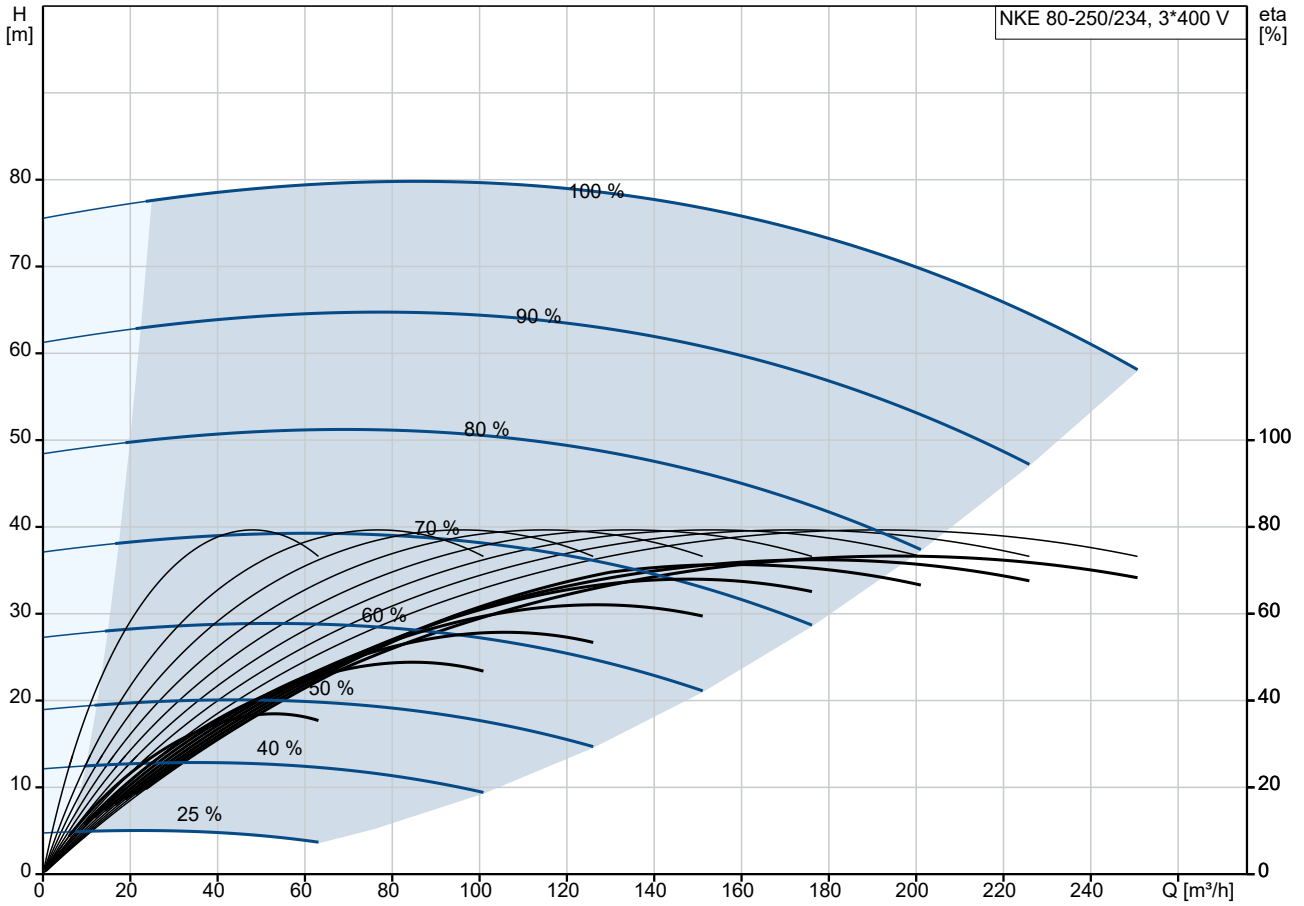

Pumped liquid = Water
 Liquid temperature during operation = 20 °C
 Density = 998.2 kg/m³

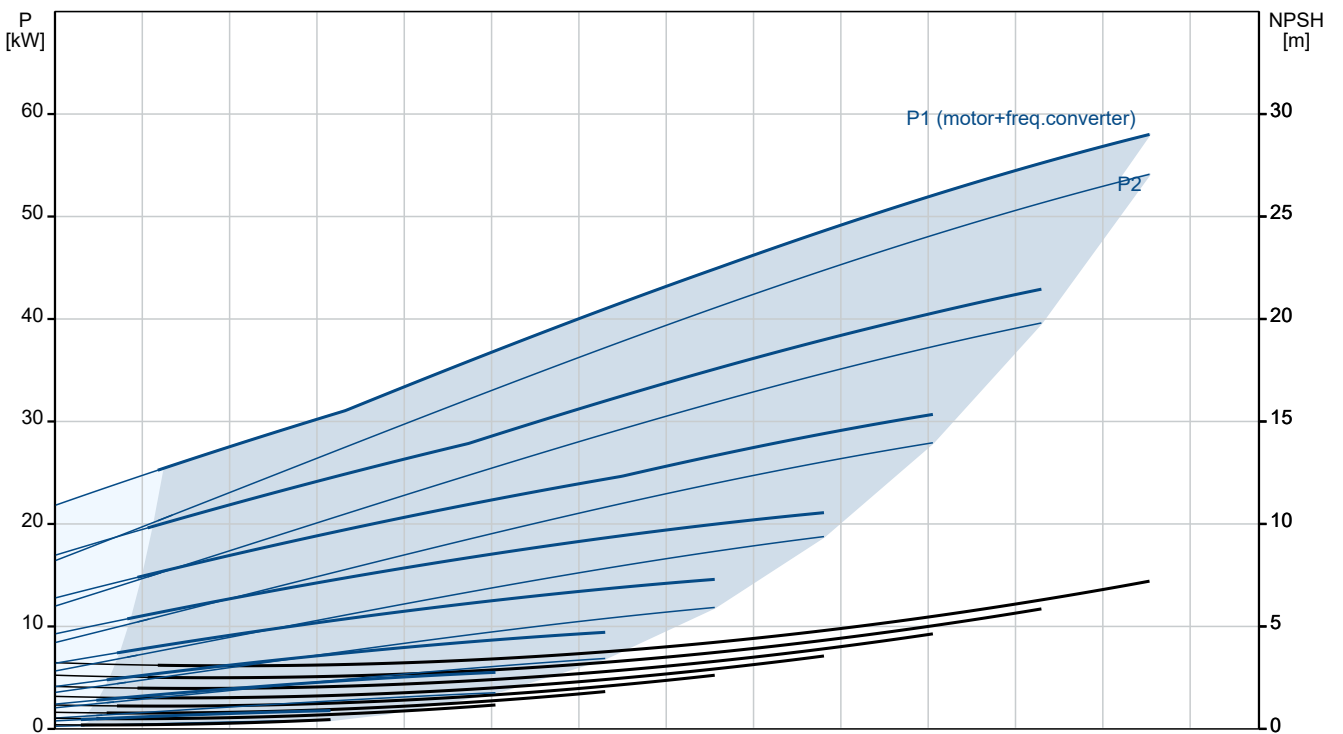

Description	Value
General information:	
Product name:	NKE 80-250/234 AIA1F2AESBQQEUW1
Product No:	On request
EAN number:	On request
Technical:	
Pump speed on which pump data are based:	2978 rpm
Rated flow:	203.6 m ³ /h
Pump with motor (Yes/No):	Y
Rated head:	69.07 m
Actual impeller diameter:	234 mm
Nominal impeller diameter:	250
Shaft diameter:	32 mm
Code for shaft seal:	BQQE
Mechanical seal type:	Single
Curve tolerance:	ISO9906:2012 3B
Pump version:	A1
Bearing design:	Standard
Materials:	
Pump housing:	Cast iron
Pump housing:	EN-GJL-250
Pump housing:	ASTM class 35
Wear ring:	Brass
Impeller:	Cast iron
Impeller:	EN-GJL-200
Impeller:	ASTM class 30
Internal pump house coating:	CED
Material code:	A
Code for rubber:	E
Shaft:	Stainless steel
Shaft:	EN 1.4301
Shaft:	AISI 304
Installation:	
Range of ambient temperature:	-10 .. 50 °C
Maximum operating pressure:	16 bar
Pipe connection standard:	EN 1092-2
Type of inlet connection:	DIN
Type of outlet connection:	DIN
Size of inlet connection:	DN 100
Size of outlet connection:	DN 80
Pressure rating for connection:	PN 16
Coupling type:	Flexible w/o spacer
Base frame design:	EN/ISO
Code for base frame:	9C ST
Grouting (Yes/No):	Y
Connect code:	F
Liquid:	
Pumped liquid:	Water
Liquid temperature range:	-25 .. 120 °C
Selected liquid temperature:	20 °C
Density:	998.2 kg/m ³
Electrical data:	
Motor type:	SIEMENS
Rated power - P2:	55 kW
Mains frequency:	50 Hz
Rated voltage:	3 x 380-420D/660-725Y V
Rated current:	95/55 A

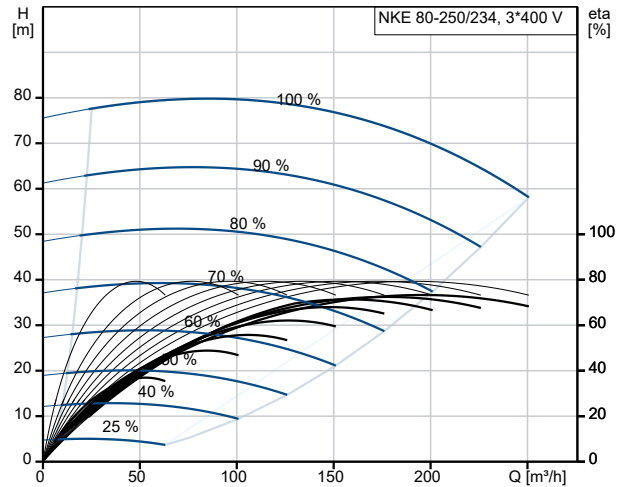

Pumped liquid = Water
Liquid temperature during operation = 20 °C
Density = 998.2 kg/m³

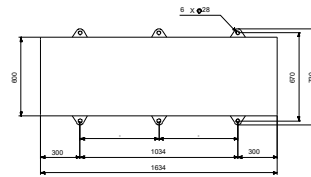
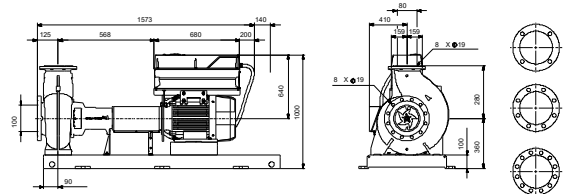
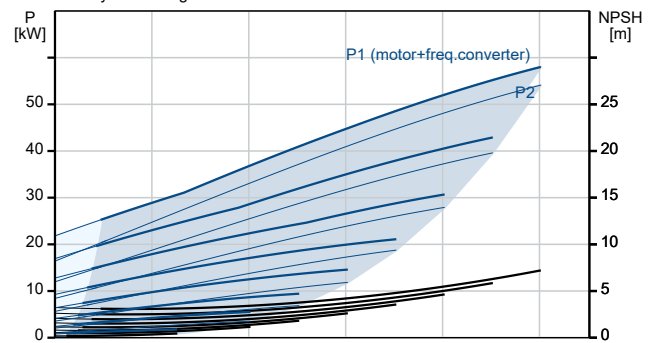



Company name:

Created by:

Phone:

Date:

24/10/2024

Description	Value
Starting current:	750 %
Cos phi - power factor:	0.88
Rated speed:	2978 rpm
IE efficiency:	IE4 95,3%
IE Efficiency class:	IE4
Motor efficiency at full load:	95.3 %
Motor efficiency at 3/4 load:	95.2 %
Motor efficiency at 1/2 load:	94.5 %
Number of poles:	2
Enclosure class (IEC 34-5):	IP55
Insulation class (IEC 85):	F
Built-in motor protection:	PTC
Motor No:	92779445
Bearing insulation type N-end:	COATED RING
Controls:	
VFD product number:	99616826
Frequency converter:	Built-in
Type of frequency converter:	CUE 3X380-500V IP55 RUG 55KW
Appr. for VFD:	CE, CULUS, C-TICK
Pressure sensor:	N
Others:	
Minimum efficiency index, MEI ≥:	0.70
Net weight:	771 kg
Gross weight:	927 kg
Shipping volume:	3.09 m ³
Country of origin:	HU
Custom tariff no.:	84137059
Language on pump nameplate:	GB

On request NKE 80-250/234 AIA1F2AESBQQEUW1 50 Hz

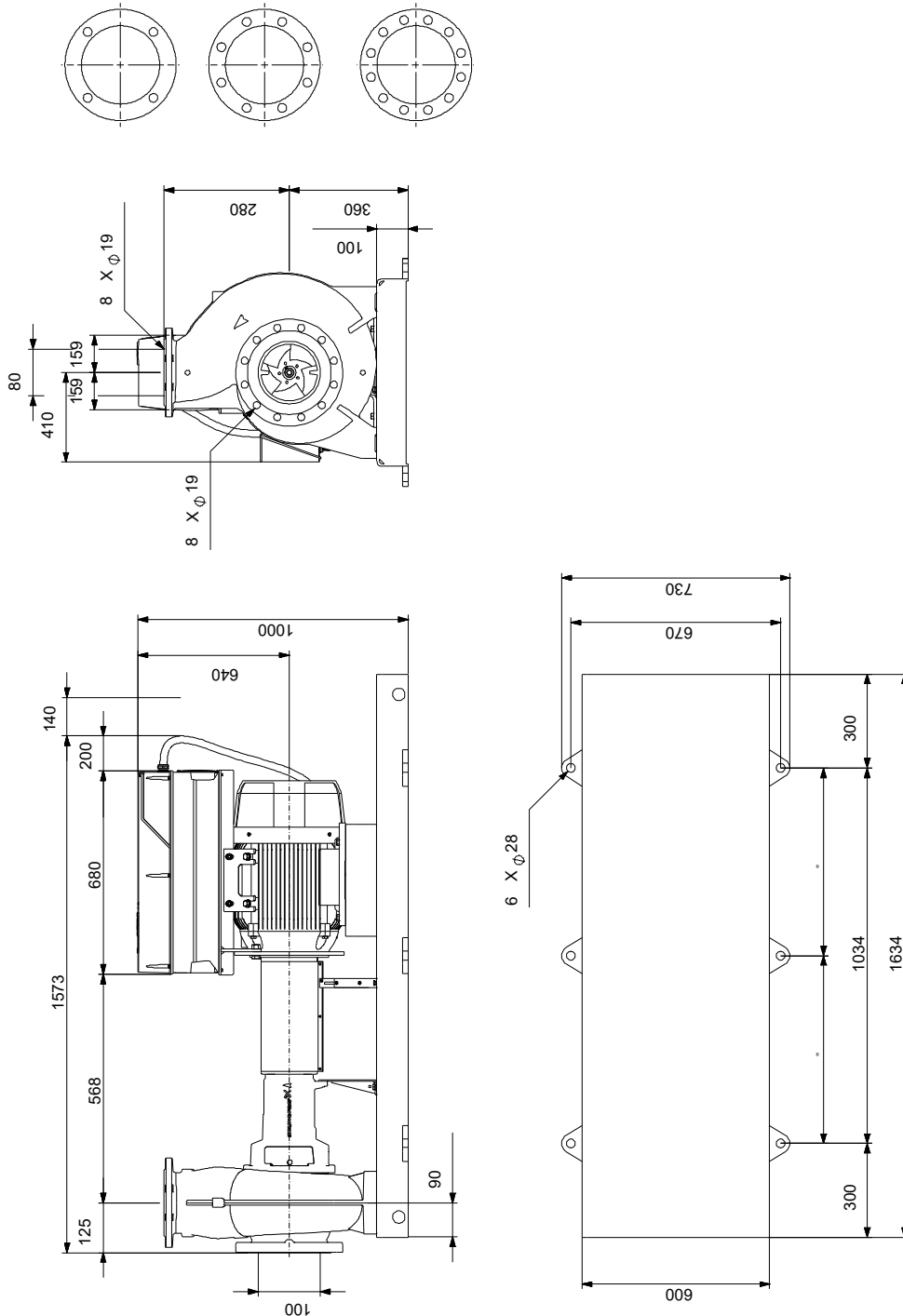

Note! All units are in [mm] unless others are stated.
Disclaimer: This simplified dimensional drawing does not show all details.

On request NKE 80-250/234 AIA1F2AESBQQEUW1 50 Hz



IEC TP211 THERMALLY PROTECTED WHEN THE THERMISTORS ARE
CONNECTED TO AMPLIFIER RELAY FOR CONTROL OF MAIN SUPPLY
THERMISTORS PTC ACCORDING TO DIN 44082

Note! All units are in [mm] unless others are stated.

