

Qty. Description

1 NKE 150-400/343 AIA1F1KVSBBQVUW3



Note! Product picture may differ from actual product

Product No.: On request

Non-self-priming, single-stage, centrifugal pump designed according to ISO 5199 with dimensions and rated performance according to EN 733. Flanges are PN 10 with dimensions according to EN 1092-1. The pump has an axial suction port, a radial discharge port and horizontal shaft. It is of the back pull-out design enabling removal of the motor, coupling, bearing bracket and impeller without disturbing the pump housing or pipework.

The unbalanced rubber bellows seal is according to DIN EN 12756.

The pump is fitted with a foot-mounted, fan-cooled asynchronous motor. Pump and motor are mounted on a common base frame.

The product's minimum efficiency index (MEI) is greater or equal to 0.70. This is by the Commission Regulation (EU) considered as an indicative benchmark for best-performing water pump available on the market as from 1 January 2013.

Pump and motor are mounted on a common steel base frame in accordance with ISO 3661. The back pull-out design makes it possible to service the pump when the pump housing is still connected to the inlet and discharge pipes.

- 1) Remove the bolts in the bearing bracket support foot and motor foot.
- 2) Remove the bearing bracket and the motor from the pump housing.

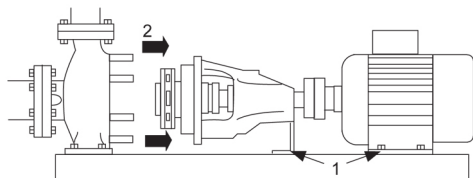

## Pump

The pump is fitted with an unbalanced rubber bellows seal with torque transmission across the spring and around the bellows. Due to the bellows, the seal does not wear the shaft, and the axial movement is not prevented by deposits on the shaft.



Seal faces:

- Rotating seal ring material: silicon carbide (SiC)
- Stationary seat material: silicon carbide (SiC)

This material pairing is used where higher corrosion resistance is required. The high hardness of this material pairing offers good resistance against abrasive particles.

Secondary seal material: FKM (fluorocarbon rubber)

FKM has excellent resistance to oils and chemicals. Above 90 °C, FKM should only be used in media without water.

The shaft is made of stainless steel and has a diameter of 42 mm where the coupling is mounted.

The pump uses a standard coupling between the pump and motor shaft.

**Qty. Description**

1

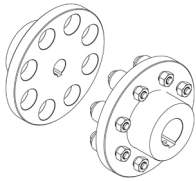

The pump has loose flanges.

The loose flanges are made of cast iron (EN-GJS-500-7/ASTM 70-50-05).

The language on the pump nameplate is English.

**Motor**

The motor is a totally enclosed, fan-cooled motor with principal dimensions to IEC and DIN standards. Electrical tolerances comply with IEC 60034.

The motor efficiency is classified as IE4 in accordance with IEC 60034-30-1.

The motor has thermistors (PTC sensors) in the windings in accordance with DIN 44081/DIN 44082. The protection reacts to both slow- and quick-rising temperatures, e.g. constant overload and stalled conditions.

Thermal switches must be connected to an external control circuit in a way which ensures that the automatic reset cannot cause accidents. The motors must be connected to a motor-protective circuit breaker according to local regulations.

The motor requires no external motor protection. The motor control unit incorporates protection against slow- and quick-rising temperatures, e.g. constant overload and stalled conditions.

**Further product details**

**Technical data**

Controls:

VFD product number: 99616826  
 Frequency converter: Built-in  
 Type of frequency converter: CUE 3X380-500V IP55 RUG 55KW  
 Appr. for VFD: CE, CULUS, C-TICK  
 Pressure sensor: N

Liquid:

Pumped liquid: Water  
 Liquid temperature range: -10 .. 90 °C  
 Selected liquid temperature: 20 °C  
 Density: 998.2 kg/m<sup>3</sup>

Technical:

Pump speed on which pump data are based: 1486 rpm  
 Rated flow: 390.5 m<sup>3</sup>/h  
 Pump with motor (Yes/No): Y  
 Rated head: 36.65 m  
 Actual impeller diameter: 343 mm  
 Nominal impeller diameter: 400  
 Code for shaft seal: BQQV  
 Mechanical seal type: Single  
 Curve tolerance: ISO9906:2012 3B  
 Bearing design: Standard

Materials:

Pump housing: Stainless steel  
 EN 1.4408  
 ASTM CF8M

Qty.	Description
1	<p>Wear ring: Stainless steel</p> <p>Flange: Cast iron EN-GJS-500-7 ASTM 70-50-05</p> <p>Impeller: Stainless steel EN 1.4408 ASTM CF8M</p> <p>Internal pump house coating: No coating</p> <p>Shaft: Stainless steel EN 1.4401 AISI 316</p> <p>Installation:</p> <p>Range of ambient temperature: -10 .. 50 °C</p> <p>Maximum operating pressure: 10 bar</p> <p>Pipe connection standard: EN 1092-1</p> <p>Type of inlet connection: DIN</p> <p>Type of outlet connection: DIN</p> <p>Size of inlet connection: DN 200</p> <p>Size of outlet connection: DN 150</p> <p>Pressure rating for connection: PN 10</p> <p>Coupling type: Flexible w/o spacer</p> <p>Base frame design: EN/ISO</p> <p>Code for base frame: 9B ST</p> <p>Grouting (Yes/No): N</p> <p>Electrical data:</p> <p>Motor type: SIEMENS</p> <p>Rated power - P2: 55 kW</p> <p>Mains frequency: 50 Hz</p> <p>Rated voltage: 3 x 380-420D/660-725Y V</p> <p>Rated current: 96.0/56.0 A</p> <p>Starting current: 820 %</p> <p>Cos phi - power factor: 0.86</p> <p>Rated speed: 1486 rpm</p> <p>IE efficiency: IE4 95,7%</p> <p>IE Efficiency class: IE4</p> <p>Motor efficiency at full load: 95.7 %</p> <p>Motor efficiency at 3/4 load: 95.8 %</p> <p>Motor efficiency at 1/2 load: 95.4 %</p> <p>Number of poles: 4</p> <p>Enclosure class (IEC 34-5): IP55</p> <p>Insulation class (IEC 85): F</p> <p>Motor No: 92691612</p> <p>Bearing insulation type N-end: COATED RING</p> <p>Others:</p> <p>Minimum efficiency index, MEI ≥: 0.70</p> <p>Net weight: 1080 kg</p> <p>Gross weight: 1240 kg</p> <p>Shipping volume: 3.09 m<sup>3</sup></p> <p>Country of origin: HU</p> <p>Custom tariff no.: 84137059</p> <p>Language on pump nameplate: GB</p>

## On request NKE 150-400/343 AIA1F1KVSBBQQVUW3 50 Hz

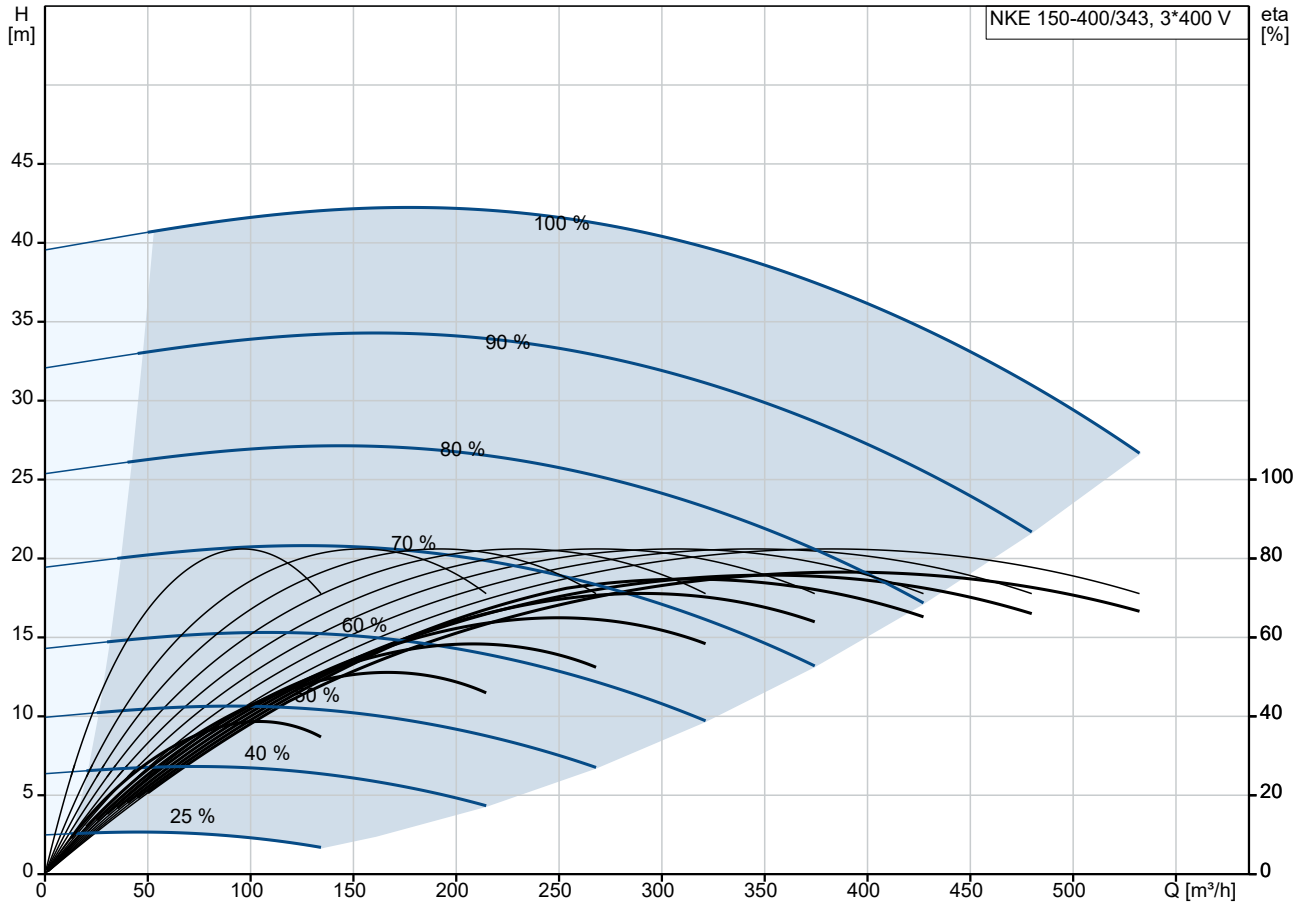

Pumped liquid = Water  
 Liquid temperature during operation = 20 °C  
 Density = 998.2 kg/m³

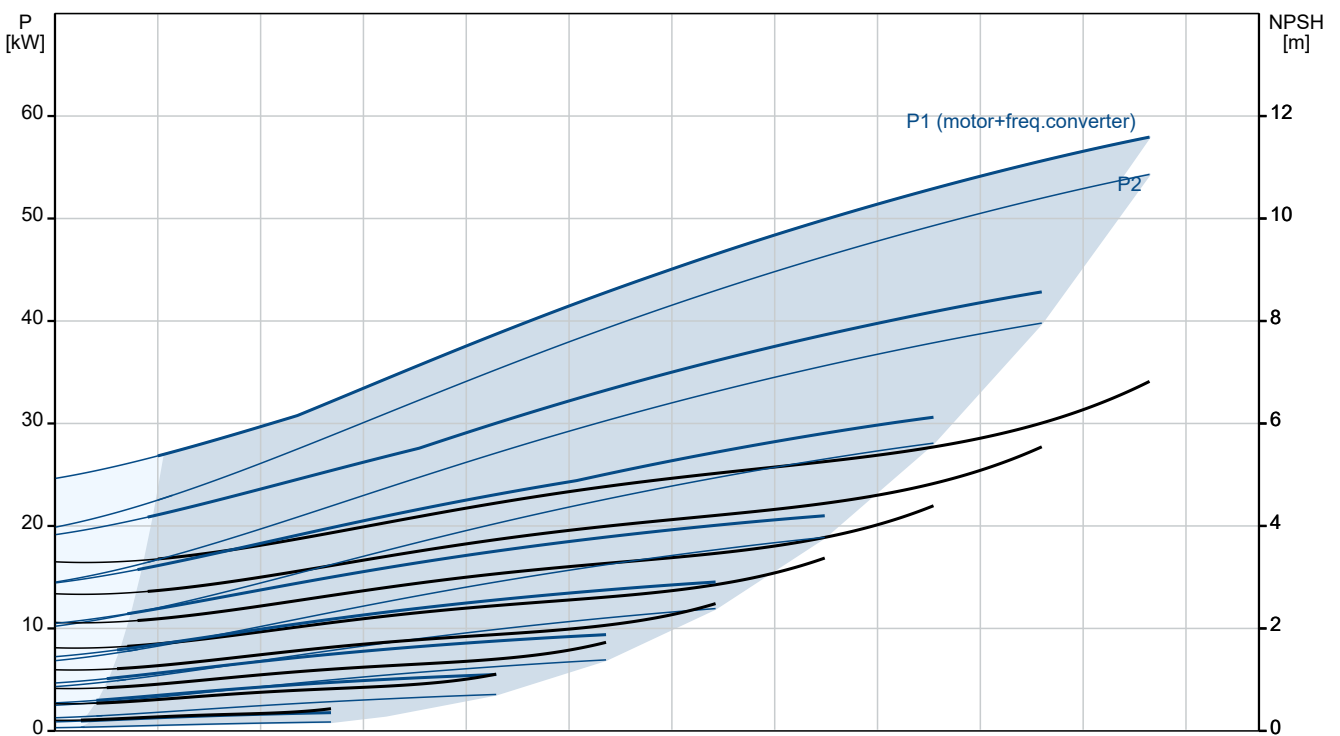

Description	Value
<b>General information:</b>	
Product name:	NKE 150-400/343 AIA1F1KVSBQQVUW3
Product No:	On request
EAN number:	On request
<b>Technical:</b>	
Pump speed on which pump data are based:	1486 rpm
Rated flow:	390.5 m <sup>3</sup> /h
Pump with motor (Yes/No):	Y
Rated head:	36.65 m
Actual impeller diameter:	343 mm
Nominal impeller diameter:	400
Shaft diameter:	42 mm
Code for shaft seal:	BQQV
Mechanical seal type:	Single
Curve tolerance:	ISO9906:2012 3B
Pump version:	A1
Bearing design:	Standard
<b>Materials:</b>	
Pump housing:	Stainless steel
Pump housing:	EN 1.4408
Pump housing:	ASTM CF8M
Wear ring:	Stainless steel
Flange:	Cast iron
Flange:	EN-GJS-500-7
Flange:	ASTM 70-50-05
Impeller:	Stainless steel
Impeller:	EN 1.4408
Impeller:	ASTM CF8M
Internal pump house coating:	No coating
Material code:	K
Code for rubber:	V
Shaft:	Stainless steel
Shaft:	EN 1.4401
Shaft:	AISI 316
<b>Installation:</b>	
Range of ambient temperature:	-10 .. 50 °C
Maximum operating pressure:	10 bar
Pipe connection standard:	EN 1092-1
Type of inlet connection:	DIN
Type of outlet connection:	DIN
Size of inlet connection:	DN 200
Size of outlet connection:	DN 150
Pressure rating for connection:	PN 10
Coupling type:	Flexible w/o spacer
Base frame design:	EN/ISO
Code for base frame:	9B ST
Grouting (Yes/No):	N
Connect code:	F
<b>Liquid:</b>	
Pumped liquid:	Water
Liquid temperature range:	-10 .. 90 °C
Selected liquid temperature:	20 °C
Density:	998.2 kg/m <sup>3</sup>
<b>Electrical data:</b>	
Motor type:	SIEMENS
Rated power - P2:	55 kW

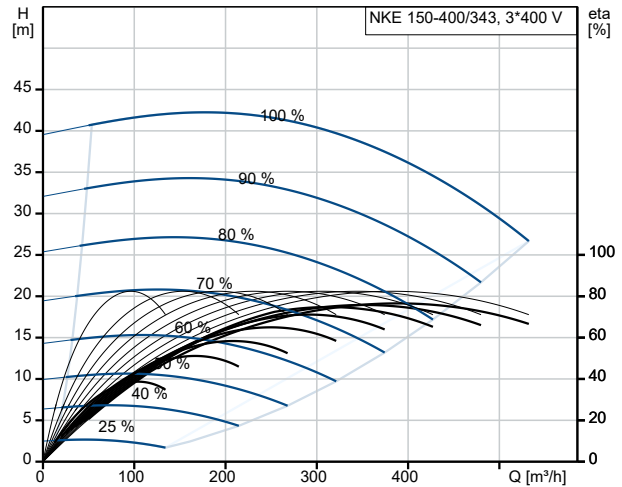

Pumped liquid = Water  
Liquid temperature during operation = 20 °C  
Density = 998.2 kg/m<sup>3</sup>

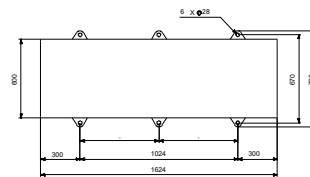
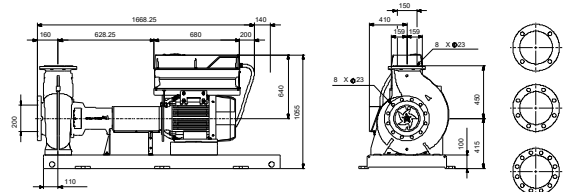
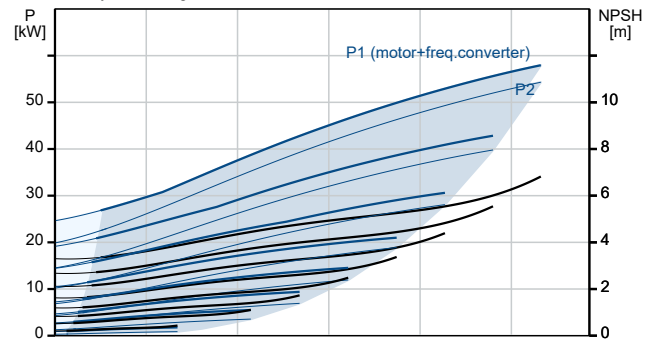

IF C1515 THERMAL PROTECTED MAINS THE THERMAL PROTECTION ARE CONNECTED TO AMPLIFIER RELAY FOR CONTROL OF MAINS SUPPLY THERMAL PROTECTION ACCORDING TO DIN 4402



Company name:

Created by:

Phone:

Date:

23/10/2024

Description	Value
Mains frequency:	50 Hz
Rated voltage:	3 x 380-420D/660-725Y V
Rated current:	96.0/56.0 A
Starting current:	820 %
Cos phi - power factor:	0.86
Rated speed:	1486 rpm
IE efficiency:	IE4 95,7%
IE Efficiency class:	IE4
Motor efficiency at full load:	95.7 %
Motor efficiency at 3/4 load:	95.8 %
Motor efficiency at 1/2 load:	95.4 %
Number of poles:	4
Enclosure class (IEC 34-5):	IP55
Insulation class (IEC 85):	F
Built-in motor protection:	PTC
Motor No:	92691612
Bearing insulation type N-end:	COATED RING
<b>Controls:</b>	
VFD product number:	99616826
Frequency converter:	Built-in
Type of frequency converter:	CUE 3X380-500V IP55 RUG 55KW
Appr. for VFD:	CE, CULUS, C-TICK
Pressure sensor:	N
<b>Others:</b>	
Minimum efficiency index, MEI ≥:	0.70
Net weight:	1080 kg
Gross weight:	1240 kg
Shipping volume:	3.09 m <sup>3</sup>
Country of origin:	HU
Custom tariff no.:	84137059
Language on pump nameplate:	GB

## On request NKE 150-400/343 AIA1F1KVSBBQQVUW3 50 Hz

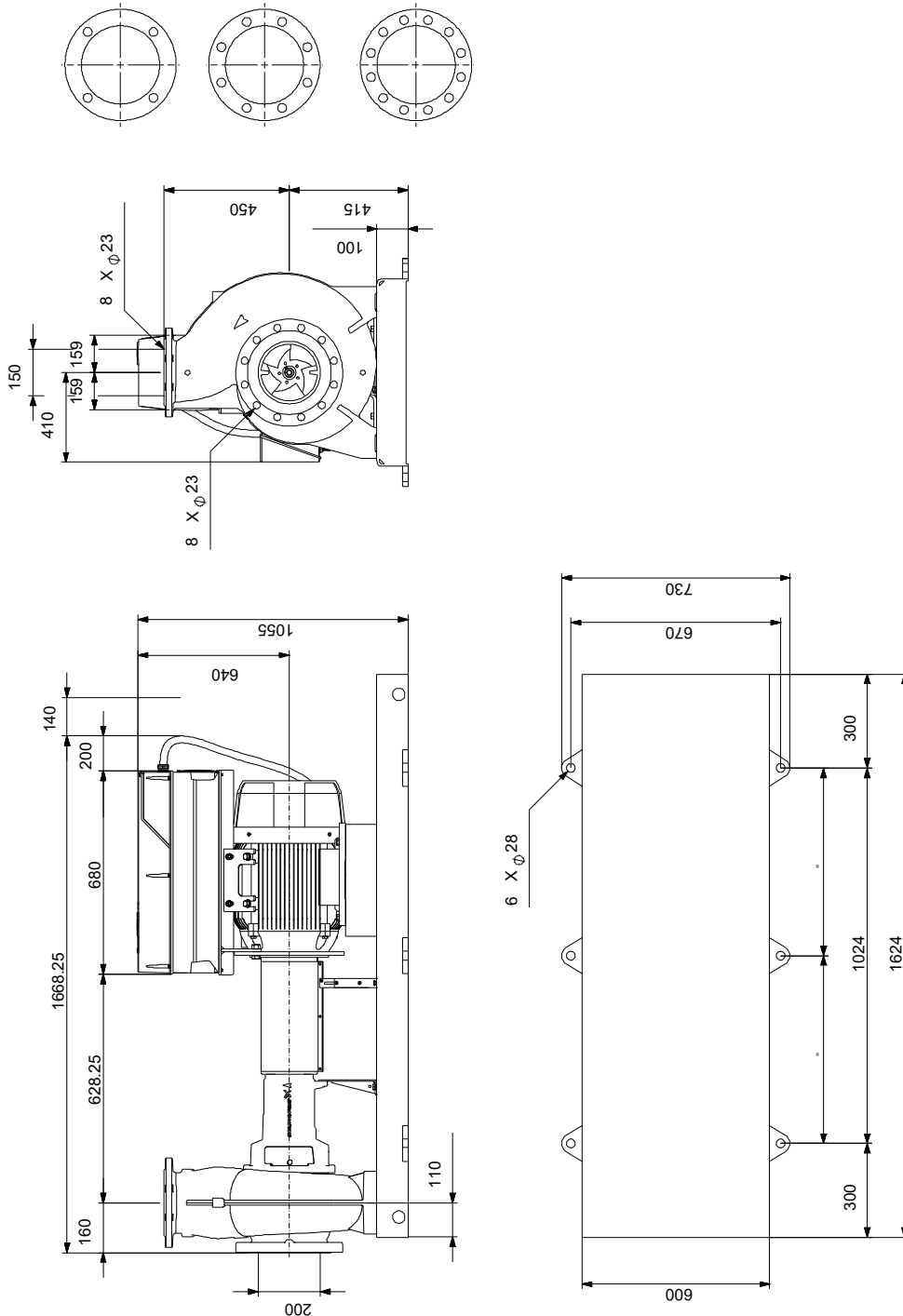

Note! All units are in [mm] unless others are stated.  
Disclaimer: This simplified dimensional drawing does not show all details.

## On request NKE 150-400/343 AIA1F1KVSBBQQVUW3 50 Hz



IEC TP211 THERMALLY PROTECTED WHEN THE THERMISTORS ARE  
CONNECTED TO AMPLIFIER RELAY FOR CONTROL OF MAIN SUPPLY  
THERMISTORS PTC ACCORDING TO DIN 44082

Note! All units are in [mm] unless others are stated.

