

**Qty. Description**

1 NKE 125-250/269 AIA2F2KESBQQERW3



Note! Product picture may differ from actual product

Product No.: On request

Non-self-priming, single-stage, centrifugal pump designed according to ISO 5199 with dimensions and rated performance according to EN 733. Flanges are PN 16 with dimensions according to EN 1092-1. The pump has an axial suction port, a radial discharge port and horizontal shaft. It is of the back pull-out design enabling removal of the motor, coupling, bearing bracket and impeller without disturbing the pump housing or pipework.

The unbalanced rubber bellows seal is according to DIN EN 12756.

The pump is fitted with a foot-mounted, fan-cooled asynchronous motor. Pump and motor are mounted on a common base frame.

Pump and motor are mounted on a common steel base frame in accordance with ISO 3661.

The back pull-out design together with a spacer coupling makes it possible to service the pump without dismantling the pump housing and motor from the base frame.

This saves realignment of pump and motor after service.

- 1) Remove coupling.
- 2) Remove the bolts in the bearing bracket support foot.
- 3) Remove the bearing bracket from the pump housing.

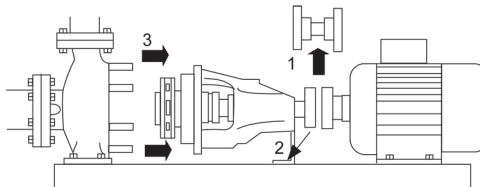

## Pump

The pump is fitted with an unbalanced rubber bellows seal with torque transmission across the spring and around the bellows. Due to the bellows, the seal does not wear the shaft, and the axial movement is not prevented by deposits on the shaft.



Seal faces:

- Rotating seal ring material: silicon carbide (SiC)
- Stationary seat material: silicon carbide (SiC)

This material pairing is used where higher corrosion resistance is required. The high hardness of this material pairing offers good resistance against abrasive particles.

Secondary seal material: EPDM (ethylene-propylene rubber)

EPDM has excellent resistance to hot water. EPDM is not suitable for mineral oils.

The shaft is made of stainless steel and has a diameter of 32 mm where the coupling is mounted.

The pump uses a spacer coupling between the pump and motor shaft.

**Qty. Description**

1



The pump has loose flanges.  
 The loose flanges are made of cast iron (EN-GJS-500-7/ASTM 70-50-05).  
 The language on the pump nameplate is English.

**Motor**

The motor is a totally enclosed, fan-cooled motor with principal dimensions to IEC and DIN standards. Electrical tolerances comply with IEC 60034.

The motor efficiency is classified as IE4 in accordance with IEC 60034-30-1.

The motor has thermistors (PTC sensors) in the windings in accordance with DIN 44081/DIN 44082. The protection reacts to both slow- and quick-rising temperatures, e.g. constant overload and stalled conditions.

Thermal switches must be connected to an external control circuit in a way which ensures that the automatic reset cannot cause accidents. The motors must be connected to a motor-protective circuit breaker according to local regulations.

The motor requires no external motor protection. The motor control unit incorporates protection against slow- and quick-rising temperatures, e.g. constant overload and stalled conditions.

**Further product details**

**Technical data**

Controls:

VFD product number: 99616823  
 Frequency converter: Built-in  
 Type of frequency converter: CUE 3X380-500V IP55 RUG 30KW  
 Appr. for VFD: CE, CULUS, C-TICK  
 Pressure sensor: N

Liquid:

Pumped liquid: Water  
 Liquid temperature range: -25 .. 120 °C  
 Selected liquid temperature: 20 °C  
 Density: 998.2 kg/m<sup>3</sup>

Technical:

Pump speed on which pump data are based: 1475 rpm  
 Rated flow: 310.3 m<sup>3</sup>/h  
 Pump with motor (Yes/No): Y  
 Rated head: 21.11 m  
 Actual impeller diameter: 269 mm  
 Nominal impeller diameter: 250  
 Code for shaft seal: BQQE  
 Mechanical seal type: Single  
 Curve tolerance: ISO9906:2012 3B  
 Bearing design: Standard

Materials:

Pump housing: Stainless steel  
 EN 1.4408

| Qty. | Description   |
|------|---|
| 1    | <p>ASTM CF8M</p> <p>Wear ring: Stainless steel</p> <p>Flange: Cast iron</p> <p>EN-GJS-500-7</p> <p>ASTM 70-50-05</p> <p>Impeller: Stainless steel</p> <p>EN 1.4408</p> <p>ASTM CF8M</p> <p>Internal pump house coating: No coating</p> <p>Shaft: Stainless steel</p> <p>EN 1.4401</p> <p>AISI 316</p> <p>Installation:</p> <p>Range of ambient temperature: -10 .. 50 °C</p> <p>Maximum operating pressure: 16 bar</p> <p>Pipe connection standard: EN 1092-1</p> <p>Type of inlet connection: DIN</p> <p>Type of outlet connection: DIN</p> <p>Size of inlet connection: DN 150</p> <p>Size of outlet connection: DN 125</p> <p>Pressure rating for connection: PN 16</p> <p>Coupling type: Flexible w/spacer</p> <p>Base frame design: EN/ISO</p> <p>Code for base frame: 8</p> <p>Grouting (Yes/No): N</p> <p>Electrical data:</p> <p>Motor type: SIEMENS</p> <p>Rated power - P2: 30 kW</p> <p>Mains frequency: 50 Hz</p> <p>Rated voltage: 3 x 380-420D/660-725Y V</p> <p>Rated current: 56.0/32.5 A</p> <p>Starting current: 730 %</p> <p>Cos phi - power factor: 0.81</p> <p>Rated speed: 1475 rpm</p> <p>IE efficiency: IE4 94,9%</p> <p>IE Efficiency class: IE4</p> <p>Motor efficiency at full load: 94.9 %</p> <p>Motor efficiency at 3/4 load: 95.2 %</p> <p>Motor efficiency at 1/2 load: 94.9 %</p> <p>Number of poles: 4</p> <p>Enclosure class (IEC 34-5): IP55</p> <p>Insulation class (IEC 85): F</p> <p>Motor No: 92691562</p> <p>Bearing insulation type N-end: COATED RING</p> <p>Others:</p> <p>Minimum efficiency index, MEI ≥: 0.57</p> <p>Net weight: 695 kg</p> <p>Gross weight: 750 kg</p> <p>Shipping volume: 1.68 m<sup>3</sup></p> <p>Country of origin: HU</p> <p>Custom tariff no.: 84137059</p> <p>Language on pump nameplate: GB</p> |

## On request NKE 125-250/269 AIA2F2KESBQQERW3 50 Hz

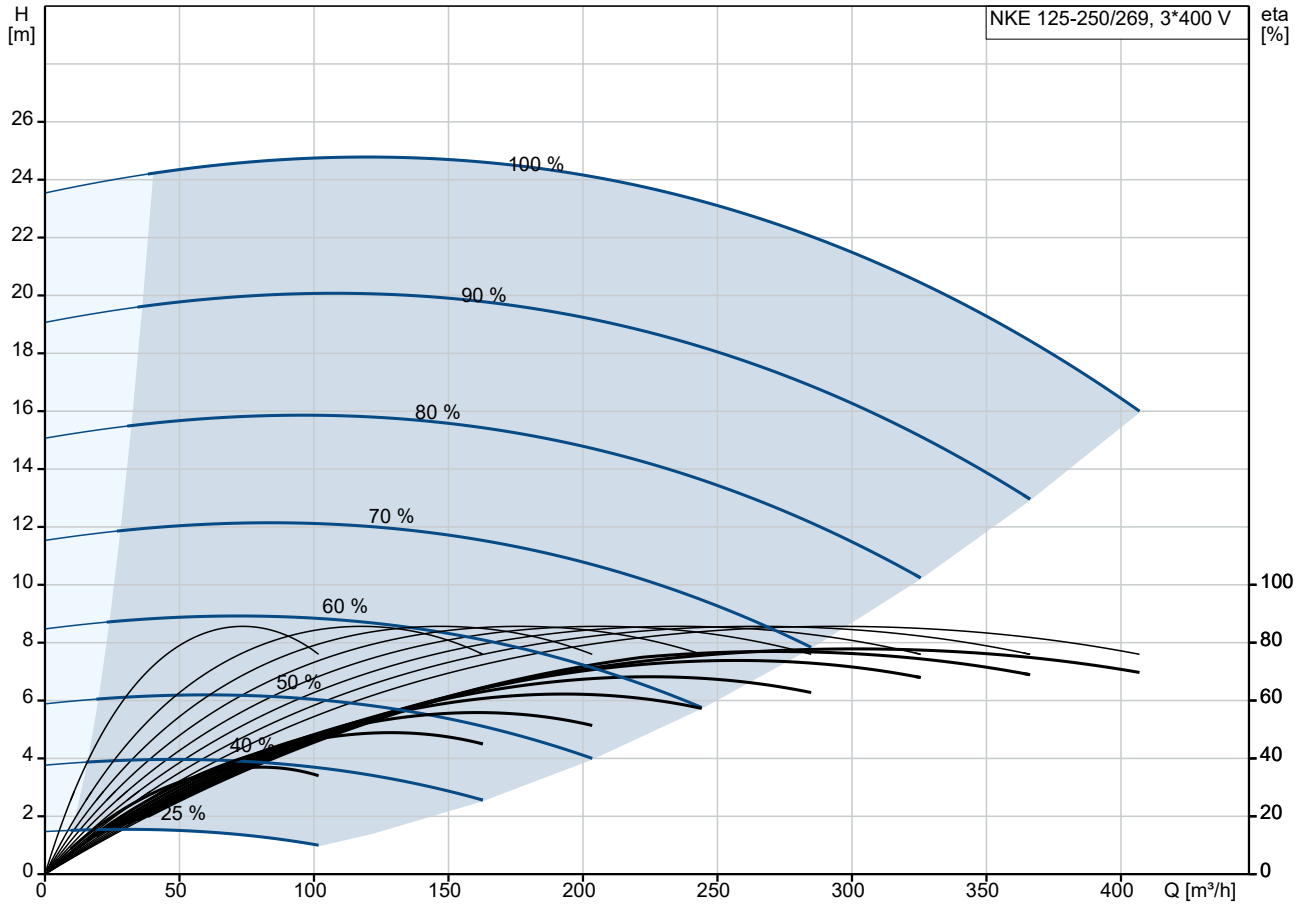

Pumped liquid = Water  
Liquid temperature during operation = 20 °C  
Density = 998.2 kg/m³

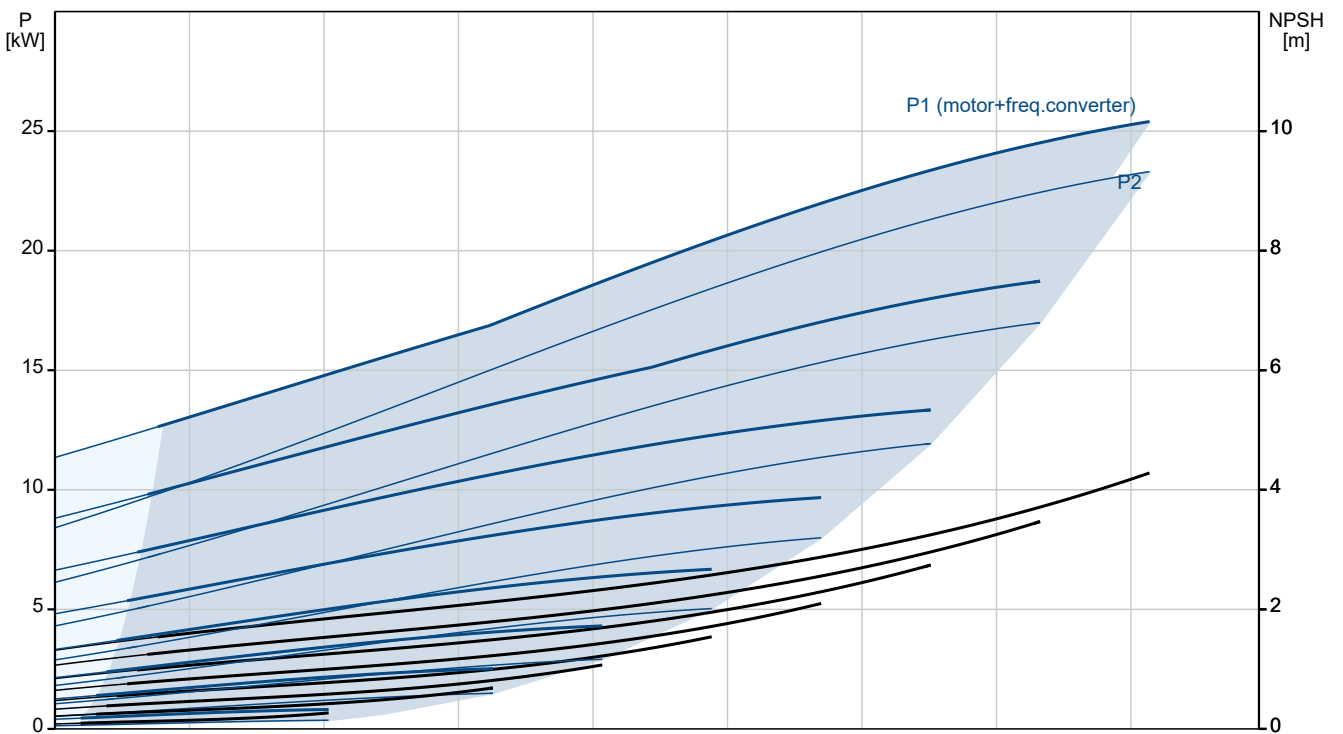

| Description                              | Value                               |
|--|-------------------------------------|
| <b>General information:</b>              |                                     |
| Product name:                            | NKE 125-250/269<br>AIA2F2KESBQQERW3 |
| Product No:                              | On request                          |
| EAN number:                              | On request                          |
| <b>Technical:</b>                        |                                     |
| Pump speed on which pump data are based: | 1475 rpm                            |
| Rated flow:                              | 310.3 m <sup>3</sup> /h             |
| Pump with motor (Yes/No):                | Y                                   |
| Rated head:                              | 21.11 m                             |
| Actual impeller diameter:                | 269 mm                              |
| Nominal impeller diameter:               | 250                                 |
| Shaft diameter:                          | 32 mm                               |
| Code for shaft seal:                     | BQQE                                |
| Mechanical seal type:                    | Single                              |
| Curve tolerance:                         | ISO9906:2012 3B                     |
| Pump version:                            | A2                                  |
| Bearing design:                          | Standard                            |
| <b>Materials:</b>                        |                                     |
| Pump housing:                            | Stainless steel                     |
| Pump housing:                            | EN 1.4408                           |
| Pump housing:                            | ASTM CF8M                           |
| Wear ring:                               | Stainless steel                     |
| Flange:                                  | Cast iron                           |
| Flange:                                  | EN-GJS-500-7                        |
| Flange:                                  | ASTM 70-50-05                       |
| Impeller:                                | Stainless steel                     |
| Impeller:                                | EN 1.4408                           |
| Impeller:                                | ASTM CF8M                           |
| Internal pump house coating:             | No coating                          |
| Material code:                           | K                                   |
| Code for rubber:                         | E                                   |
| Shaft:                                   | Stainless steel                     |
| Shaft:                                   | EN 1.4401                           |
| Shaft:                                   | AISI 316                            |
| <b>Installation:</b>                     |                                     |
| Range of ambient temperature:            | -10 .. 50 °C                        |
| Maximum operating pressure:              | 16 bar                              |
| Pipe connection standard:                | EN 1092-1                           |
| Type of inlet connection:                | DIN                                 |
| Type of outlet connection:               | DIN                                 |
| Size of inlet connection:                | DN 150                              |
| Size of outlet connection:               | DN 125                              |
| Pressure rating for connection:          | PN 16                               |
| Coupling type:                           | Flexible w/spacer                   |
| Base frame design:                       | EN/ISO                              |
| Code for base frame:                     | 8                                   |
| Grouting (Yes/No):                       | N                                   |
| Connect code:                            | F                                   |
| <b>Liquid:</b>                           |                                     |
| Pumped liquid:                           | Water                               |
| Liquid temperature range:                | -25 .. 120 °C                       |
| Selected liquid temperature:             | 20 °C                               |
| Density:                                 | 998.2 kg/m <sup>3</sup>             |
| <b>Electrical data:</b>                  |                                     |
| Motor type:                              | SIEMENS                             |
| Rated power - P2:                        | 30 kW                               |

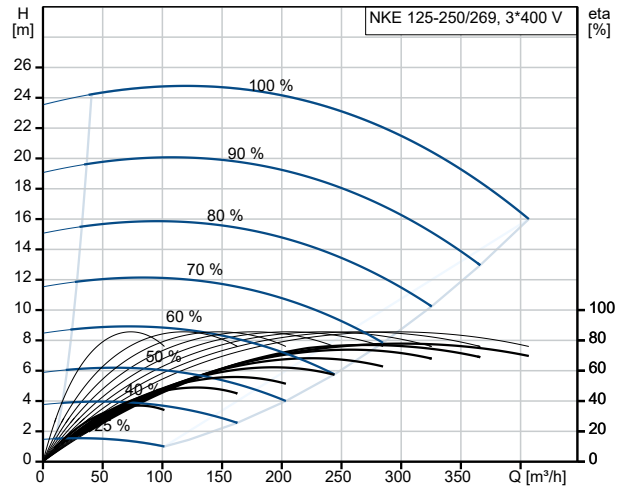

Pumped liquid = Water  
 Liquid temperature during operation = 20 °C  
 Density = 998.2 kg/m<sup>3</sup>

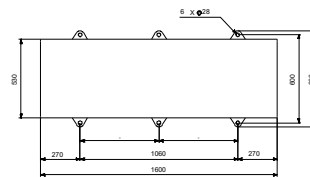
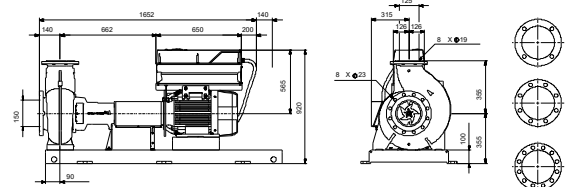
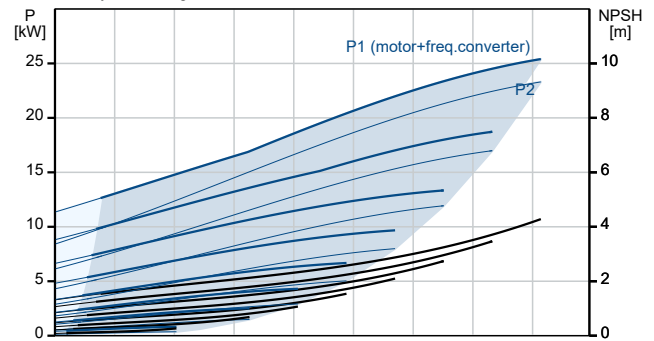

IF THE THERMAL PROTECTED MAINS SUPPLIERS ARE CONNECTED TO AMPLIFIER RELAY FOR CONTROL OF MAINS SUPPLY THE THERMOSTORE PTC ACCORDING TO DIN 4482



Company name:

Created by:

Phone:

Date:

23/10/2024

| Description                      | Value                           |
|----------------------------------|---------------------------------|
| Mains frequency:                 | 50 Hz                           |
| Rated voltage:                   | 3 x 380-420D/660-725Y V         |
| Rated current:                   | 56.0/32.5 A                     |
| Starting current:                | 730 %                           |
| Cos phi - power factor:          | 0.81                            |
| Rated speed:                     | 1475 rpm                        |
| IE efficiency:                   | IE4 94,9%                       |
| IE Efficiency class:             | IE4                             |
| Motor efficiency at full load:   | 94.9 %                          |
| Motor efficiency at 3/4 load:    | 95.2 %                          |
| Motor efficiency at 1/2 load:    | 94.9 %                          |
| Number of poles:                 | 4                               |
| Enclosure class (IEC 34-5):      | IP55                            |
| Insulation class (IEC 85):       | F                               |
| Built-in motor protection:       | PTC                             |
| Motor No:                        | 92691562                        |
| Bearing insulation type N-end:   | COATED RING                     |
| <b>Controls:</b>                 |                                 |
| VFD product number:              | 99616823                        |
| Frequency converter:             | Built-in                        |
| Type of frequency converter:     | CUE 3X380-500V IP55 RUG<br>30KW |
| Appr. for VFD:                   | CE, CULUS, C-TICK               |
| Pressure sensor:                 | N                               |
| <b>Others:</b>                   |                                 |
| Minimum efficiency index, MEI ≥: | 0.57                            |
| Net weight:                      | 695 kg                          |
| Gross weight:                    | 750 kg                          |
| Shipping volume:                 | 1.68 m <sup>3</sup>             |
| Country of origin:               | HU                              |
| Custom tariff no.:               | 84137059                        |
| Language on pump nameplate:      | GB                              |

## On request NKE 125-250/269 AIA2F2KESBQQERW3 50 Hz

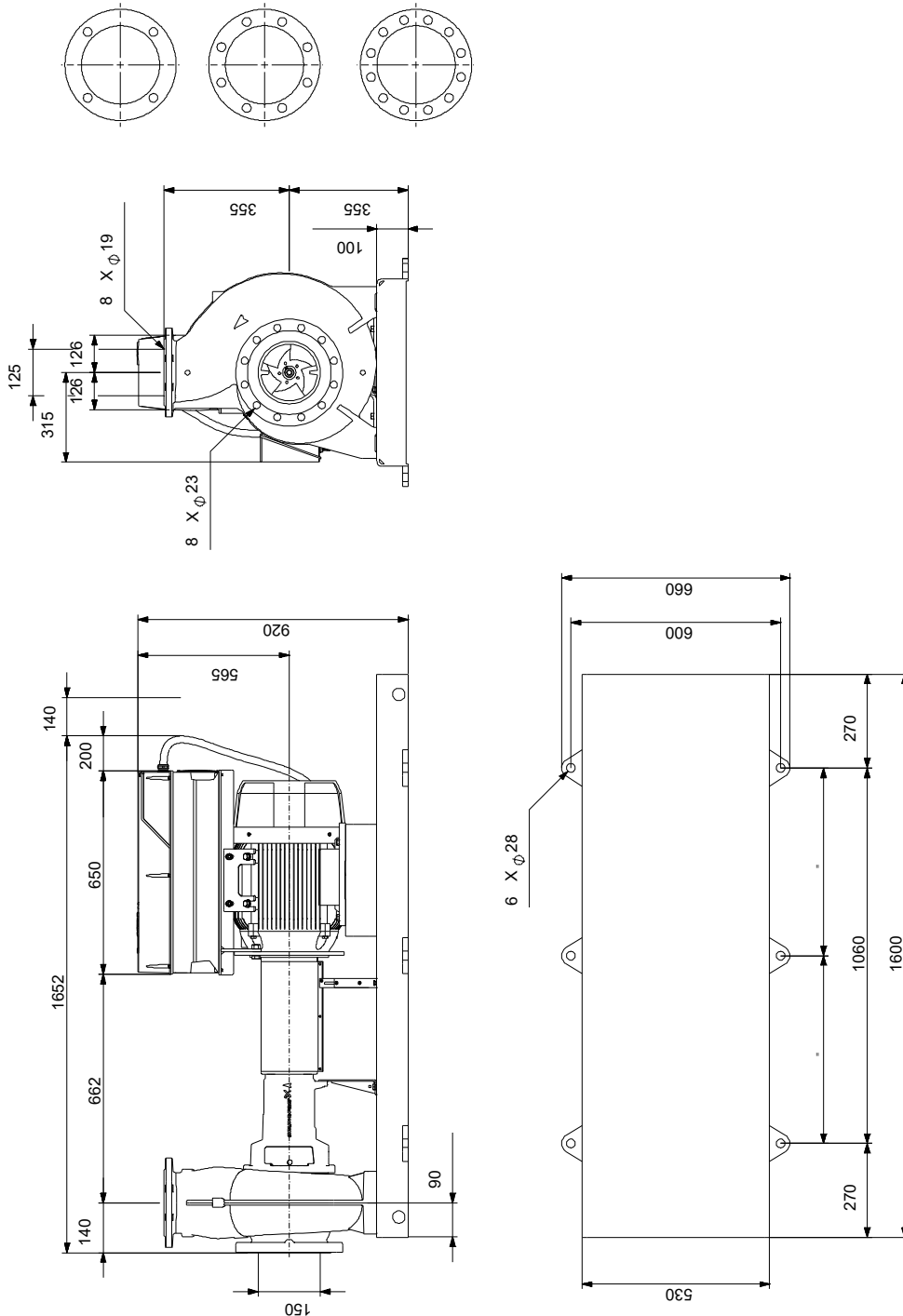

Note! All units are in [mm] unless others are stated.  
Disclaimer: This simplified dimensional drawing does not show all details.

## On request NKE 125-250/269 AIA2F2KESBQQERW3 50 Hz



IEC TP211 THERMALLY PROTECTED WHEN THE THERMISTORS ARE  
CONNECTED TO AMPLIFIER RELAY FOR CONTROL OF MAIN SUPPLY  
THERMISTORS PTC ACCORDING TO DIN 44082

Note! All units are in [mm] unless others are stated.

