

Qty. Description

1 NKE 100-400/375 BIA2F2KESBQQESW3



Note! Product picture may differ from actual product

Product No.: On request

Non-self-priming, single-stage, centrifugal pump designed according to ISO 5199 with dimensions and rated performance according to EN 733. Flanges are PN 16 with dimensions according to EN 1092-1. The pump has an axial suction port, a radial discharge port and horizontal shaft. It is of the back pull-out design enabling removal of the motor, coupling, bearing bracket and impeller without disturbing the pump housing or pipework.

The unbalanced rubber bellows seal is according to DIN EN 12756.

The pump is fitted with a foot-mounted, fan-cooled asynchronous motor. Pump and motor are mounted on a common base frame.

The product's minimum efficiency index (MEI) is greater or equal to 0.70. This is by the Commission Regulation (EU) considered as an indicative benchmark for best-performing water pump available on the market as from 1 January 2013.

Pump and motor are mounted on a common steel base frame in accordance with ISO 3661.

The back pull-out design together with a spacer coupling makes it possible to service the pump without dismantling the pump housing and motor from the base frame.

This saves realignment of pump and motor after service.

- 1) Remove coupling.
- 2) Remove the bolts in the bearing bracket support foot.
- 3) Remove the bearing bracket from the pump housing.

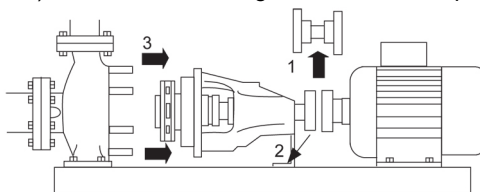

## Pump

The pump is fitted with an unbalanced rubber bellows seal with torque transmission across the spring and around the bellows. Due to the bellows, the seal does not wear the shaft, and the axial movement is not prevented by deposits on the shaft.



Seal faces:

- Rotating seal ring material: silicon carbide (SiC)
- Stationary seat material: silicon carbide (SiC)

This material pairing is used where higher corrosion resistance is required. The high hardness of this material pairing offers good resistance against abrasive particles.

Secondary seal material: EPDM (ethylene-propylene rubber)

EPDM has excellent resistance to hot water. EPDM is not suitable for mineral oils.

The shaft is made of stainless steel and has a diameter of 42 mm where the coupling is mounted.

The pump uses a spacer coupling between the pump and motor shaft.

**Qty. Description**

1



The pump has loose flanges.  
 The loose flanges are made of cast iron (EN-GJS-500-7/ASTM 70-50-05).  
 The language on the pump nameplate is English.

**Motor**

The motor is a totally enclosed, fan-cooled motor with principal dimensions to IEC and DIN standards. Electrical tolerances comply with IEC 60034.

The motor efficiency is classified as IE4 in accordance with IEC 60034-30-1.

The motor has thermistors (PTC sensors) in the windings in accordance with DIN 44081/DIN 44082. The protection reacts to both slow- and quick-rising temperatures, e.g. constant overload and stalled conditions.

Thermal switches must be connected to an external control circuit in a way which ensures that the automatic reset cannot cause accidents. The motors must be connected to a motor-protective circuit breaker according to local regulations.

The motor requires no external motor protection. The motor control unit incorporates protection against slow- and quick-rising temperatures, e.g. constant overload and stalled conditions.

The motor is equipped with bearing current protection. This protects the bearings from failure due to bearing currents, which can be caused e.g. by the high-frequency switching of a variable frequency drive.

**Further product details**

**Technical data**

Controls:

VFD product number: 99616824  
 Frequency converter: Built-in  
 Type of frequency converter: CUE 3X380-500V IP55 RUG 37KW  
 Appr. for VFD: CE, CULUS, C-TICK  
 Pressure sensor: N

Liquid:

Pumped liquid: Water  
 Liquid temperature range: -25 .. 120 °C  
 Selected liquid temperature: 20 °C  
 Density: 998.2 kg/m<sup>3</sup>

Technical:

Pump speed on which pump data are based: 1485 rpm  
 Rated flow: 210 m<sup>3</sup>/h  
 Pump with motor (Yes/No): Y  
 Rated head: 44.16 m  
 Actual impeller diameter: 375 mm  
 Nominal impeller diameter: 400  
 Code for shaft seal: BQQE  
 Mechanical seal type: Single  
 Curve tolerance: ISO9906:2012 3B  
 Bearing design: Standard

Materials:

Qty.	Description
1	Pump housing: Stainless steel EN 1.4408 ASTM CF8M Wear ring: Stainless steel Flange: Cast iron EN-GJS-500-7 ASTM 70-50-05 Impeller: Stainless steel EN 1.4408 ASTM CF8M Internal pump house coating: No coating Shaft: Stainless steel EN 1.4401 AISI 316  Installation: Range of ambient temperature: -10 .. 50 °C Maximum operating pressure: 16 bar Pipe connection standard: EN 1092-1 Type of inlet connection: DIN Type of outlet connection: DIN Size of inlet connection: DN 125 Size of outlet connection: DN 100 Pressure rating for connection: PN 16 Coupling type: Flexible w/spacer Base frame design: EN/ISO Code for base frame: 9 Grouting (Yes/No): N  Electrical data: Motor type: SIEMENS Rated power - P2: 37 kW Mains frequency: 50 Hz Rated voltage: 3 x 380-420D/660-725Y V Rated current: 67.0/38.5 A Starting current: 840 % Cos phi - power factor: 0.84 Rated speed: 1485 rpm IE efficiency: IE4 95,4% IE Efficiency class: IE4 Motor efficiency at full load: 95.4 % Motor efficiency at 3/4 load: 95.4 % Motor efficiency at 1/2 load: 94.8 % Number of poles: 4 Enclosure class (IEC 34-5): IP55 Insulation class (IEC 85): F Motor No: 92691591 Bearing insulation type N-end: CERAMIC SHAFT COATING  Others: Minimum efficiency index, MEI ≥: 0.70 Net weight: 937 kg Gross weight: 1090 kg Shipping volume: 3.09 m <sup>3</sup> Country of origin: HU Custom tariff no.: 84137059 Language on pump nameplate: GB

## On request NKE 100-400/375 BIA2F2KESBQQESW3 50 Hz

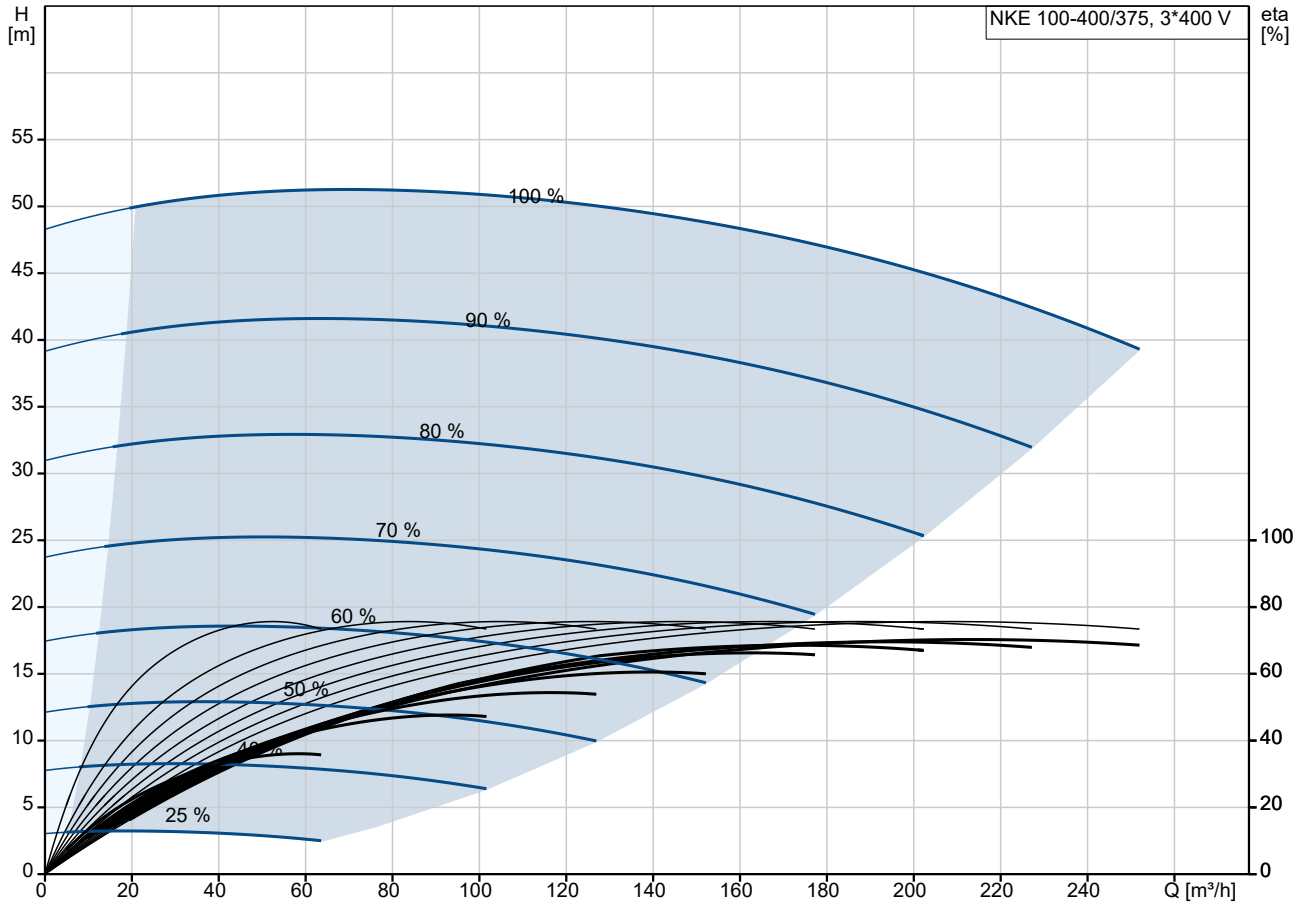

Pumped liquid = Water  
 Liquid temperature during operation = 20 °C  
 Density = 998.2 kg/m³

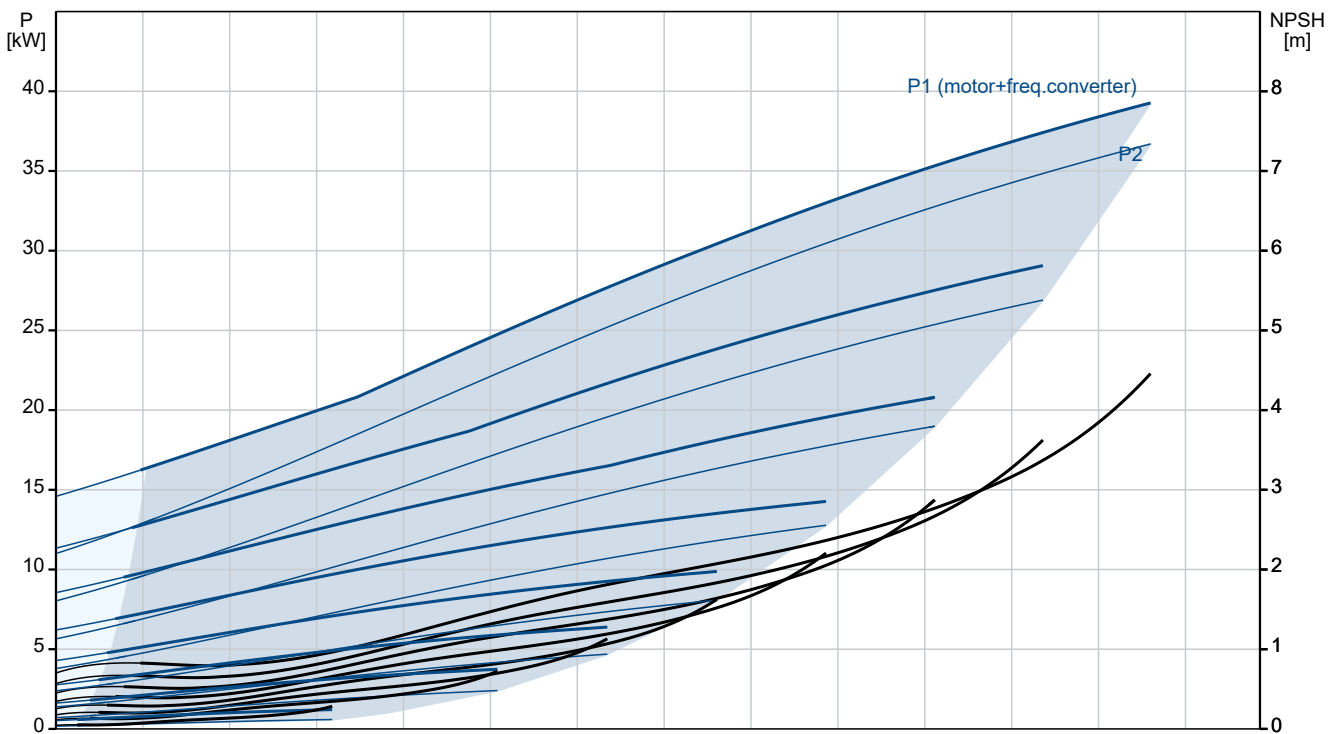

Description	Value
<b>General information:</b>	
Product name:	NKE 100-400/375 BIA2F2KESBQQESW3
Product No:	On request
EAN number:	On request
<b>Technical:</b>	
Pump speed on which pump data are based:	1485 rpm
Rated flow:	210 m <sup>3</sup> /h
Pump with motor (Yes/No):	Y
Rated head:	44.16 m
Actual impeller diameter:	375 mm
Nominal impeller diameter:	400
Shaft diameter:	42 mm
Code for shaft seal:	BQQE
Mechanical seal type:	Single
Curve tolerance:	ISO9906:2012 3B
Pump version:	A2
Bearing design:	Standard
<b>Materials:</b>	
Pump housing:	Stainless steel
Pump housing:	EN 1.4408
Pump housing:	ASTM CF8M
Wear ring:	Stainless steel
Flange:	Cast iron
Flange:	EN-GJS-500-7
Flange:	ASTM 70-50-05
Impeller:	Stainless steel
Impeller:	EN 1.4408
Impeller:	ASTM CF8M
Internal pump house coating:	No coating
Material code:	K
Code for rubber:	E
Shaft:	Stainless steel
Shaft:	EN 1.4401
Shaft:	AISI 316
<b>Installation:</b>	
Range of ambient temperature:	-10 .. 50 °C
Maximum operating pressure:	16 bar
Pipe connection standard:	EN 1092-1
Type of inlet connection:	DIN
Type of outlet connection:	DIN
Size of inlet connection:	DN 125
Size of outlet connection:	DN 100
Pressure rating for connection:	PN 16
Coupling type:	Flexible w/spacer
Base frame design:	EN/ISO
Code for base frame:	9
Grouting (Yes/No):	N
Connect code:	F
<b>Liquid:</b>	
Pumped liquid:	Water
Liquid temperature range:	-25 .. 120 °C
Selected liquid temperature:	20 °C
Density:	998.2 kg/m <sup>3</sup>
<b>Electrical data:</b>	
Motor type:	SIEMENS
Rated power - P2:	37 kW

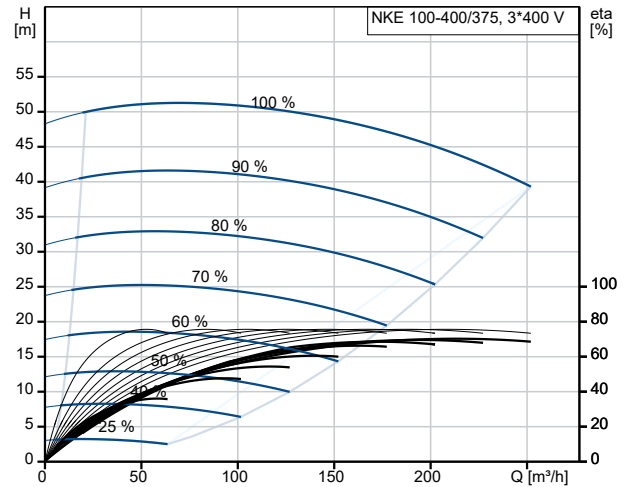

Pumped liquid = Water  
Liquid temperature during operation = 20 °C  
Density = 998.2 kg/m<sup>3</sup>

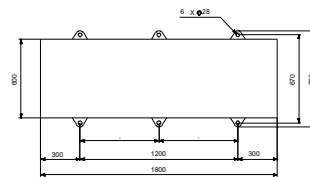
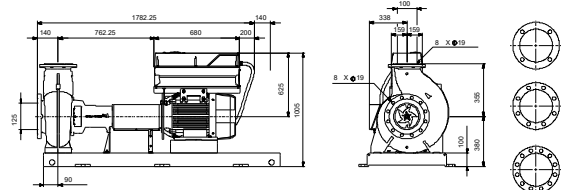
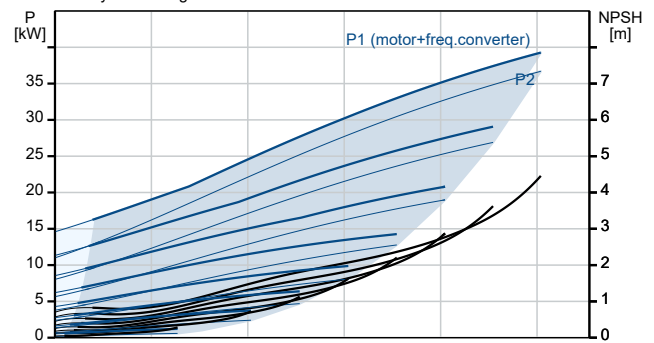

IF C1713 THERMAL PROTECTED MAINS THE THERMOSTATS ARE CONNECTED TO AMPLIFIER RELAY FOR CONTROL OF MAINS SUPPLY THERMOSTATS PTC ACCORDING TO DIN 4402



Company name:

Created by:

Phone:

Date:

22/10/2024

Description	Value
Mains frequency:	50 Hz
Rated voltage:	3 x 380-420D/660-725Y V
Rated current:	67.0/38.5 A
Starting current:	840 %
Cos phi - power factor:	0.84
Rated speed:	1485 rpm
IE efficiency:	IE4 95,4%
IE Efficiency class:	IE4
Motor efficiency at full load:	95.4 %
Motor efficiency at 3/4 load:	95.4 %
Motor efficiency at 1/2 load:	94.8 %
Number of poles:	4
Enclosure class (IEC 34-5):	IP55
Insulation class (IEC 85):	F
Built-in motor protection:	PTC
Motor No:	92691591
Bearing insulation type N-end:	CERAMIC SHAFT COATING
<b>Controls:</b>	
VFD product number:	99616824
Frequency converter:	Built-in
Type of frequency converter:	CUE 3X380-500V IP55 RUG 37KW
Appr. for VFD:	CE, CULUS, C-TICK
Pressure sensor:	N
<b>Others:</b>	
Minimum efficiency index, MEI ≥:	0.70
Net weight:	937 kg
Gross weight:	1090 kg
Shipping volume:	3.09 m <sup>3</sup>
Country of origin:	HU
Custom tariff no.:	84137059
Language on pump nameplate:	GB

## On request NKE 100-400/375 BIA2F2KESBQQESW3 50 Hz

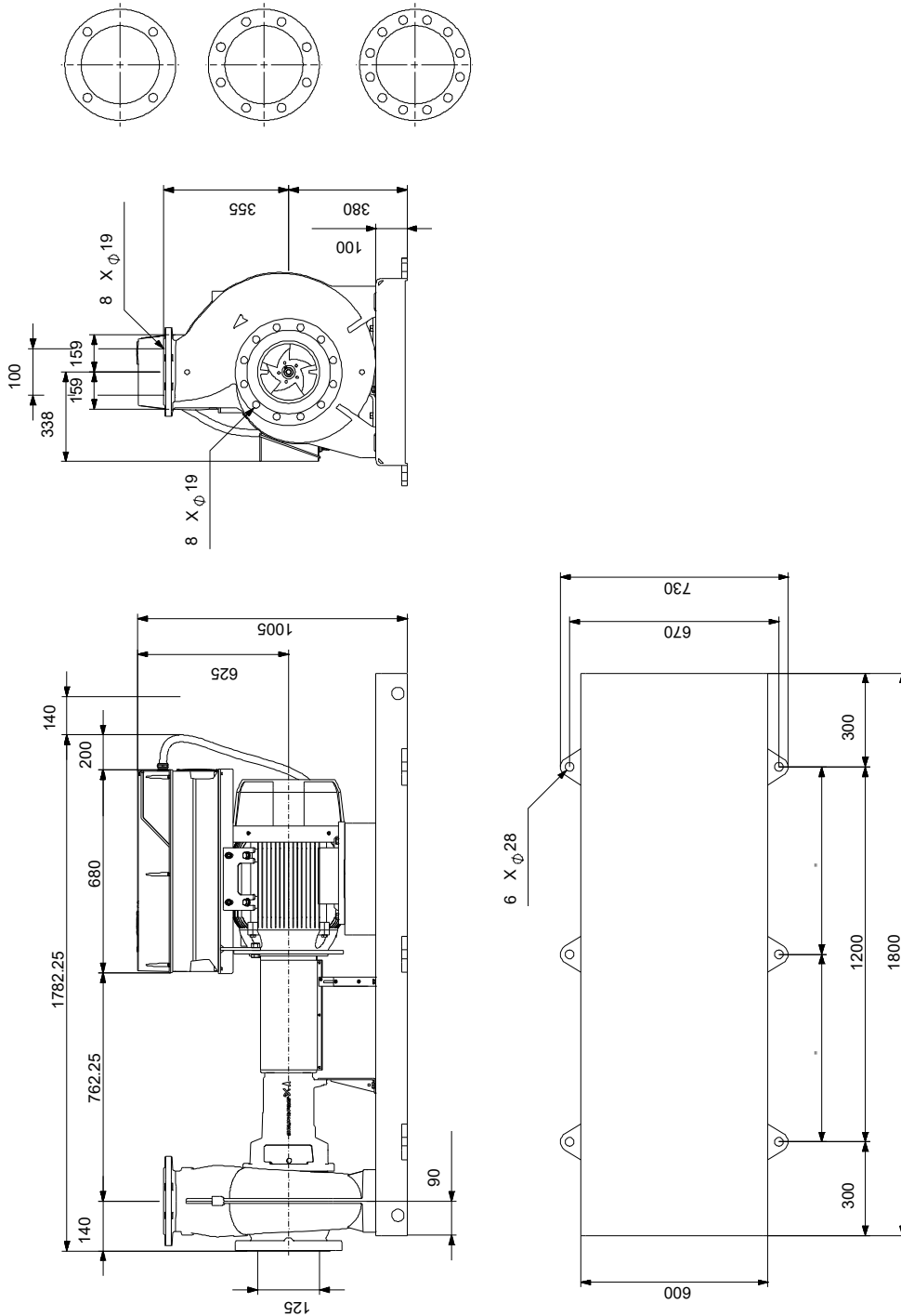

Note! All units are in [mm] unless others are stated.  
 Disclaimer: This simplified dimensional drawing does not show all details.

## On request NKE 100-400/375 BIA2F2KESBQQESW3 50 Hz



IEC TP211 THERMALLY PROTECTED WHEN THE THERMISTORS ARE  
CONNECTED TO AMPLIFIER RELAY FOR CONTROL OF MAIN SUPPLY  
THERMISTORS PTC ACCORDING TO DIN 44082

Note! All units are in [mm] unless others are stated.

