

Qty. Description

1 NKE 150-315.2/314 AIA2F1KVSBBQVTW3



Note! Product picture may differ from actual product

Product No.: On request

Non-self-priming, single-stage, centrifugal pump designed according to ISO 5199 with dimensions and rated performance according to EN 733. Flanges are PN 10 with dimensions according to EN 1092-1. The pump has an axial suction port, a radial discharge port and horizontal shaft. It is of the back pull-out design enabling removal of the motor, coupling, bearing bracket and impeller without disturbing the pump housing or pipework.

The unbalanced rubber bellows seal is according to DIN EN 12756.

The pump is fitted with a foot-mounted, fan-cooled asynchronous motor. Pump and motor are mounted on a common base frame.

Pump and motor are mounted on a common steel base frame in accordance with ISO 3661.

The back pull-out design together with a spacer coupling makes it possible to service the pump without dismantling the pump housing and motor from the base frame.

This saves realignment of pump and motor after service.

- 1) Remove coupling.
- 2) Remove the bolts in the bearing bracket support foot.
- 3) Remove the bearing bracket from the pump housing.

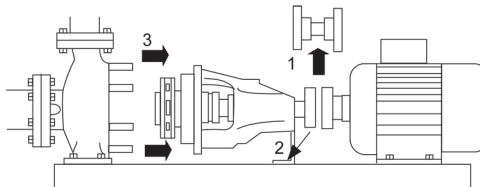

Pump

The pump is fitted with an unbalanced rubber bellows seal with torque transmission across the spring and around the bellows. Due to the bellows, the seal does not wear the shaft, and the axial movement is not prevented by deposits on the shaft.



Seal faces:

- Rotating seal ring material: silicon carbide (SiC)
- Stationary seat material: silicon carbide (SiC)

This material pairing is used where higher corrosion resistance is required. The high hardness of this material pairing offers good resistance against abrasive particles.

Secondary seal material: FKM (fluorocarbon rubber)

FKM has excellent resistance to oils and chemicals. Above 90 °C, FKM should only be used in media without water.

The shaft is made of stainless steel and has a diameter of 42 mm where the coupling is mounted.

The pump uses a spacer coupling between the pump and motor shaft.

Qty. Description

1



The pump has loose flanges.
 The loose flanges are made of cast iron (EN-GJS-500-7/ASTM 70-50-05).
 The language on the pump nameplate is English.

Motor

The motor is a totally enclosed, fan-cooled motor with principal dimensions to IEC and DIN standards. Electrical tolerances comply with IEC 60034.

The motor efficiency is classified as IE4 in accordance with IEC 60034-30-1.

The motor has thermistors (PTC sensors) in the windings in accordance with DIN 44081/DIN 44082. The protection reacts to both slow- and quick-rising temperatures, e.g. constant overload and stalled conditions.

Thermal switches must be connected to an external control circuit in a way which ensures that the automatic reset cannot cause accidents. The motors must be connected to a motor-protective circuit breaker according to local regulations.

The motor requires no external motor protection. The motor control unit incorporates protection against slow- and quick-rising temperatures, e.g. constant overload and stalled conditions.

The motor is equipped with bearing current protection. This protects the bearings from failure due to bearing currents, which can be caused e.g. by the high-frequency switching of a variable frequency drive.

Further product details

Technical data

Controls:

VFD product number: 99616825
 Frequency converter: Built-in
 Type of frequency converter: CUE 3X380-500V IP55 RUG 45KW
 Appr. for VFD: CE, CULUS, C-TICK
 Pressure sensor: N

Liquid:

Pumped liquid: Water
 Liquid temperature range: -10 .. 90 °C
 Selected liquid temperature: 20 °C
 Density: 998.2 kg/m³

Technical:

Pump speed on which pump data are based: 1485 rpm
 Rated flow: 482 m³/h
 Pump with motor (Yes/No): Y
 Rated head: 27.8 m
 Actual impeller diameter: 314 mm
 Nominal impeller diameter: 315.2
 Code for shaft seal: BQQV
 Mechanical seal type: Single
 Curve tolerance: ISO9906:2012 3B
 Bearing design: Standard

Materials:

Qty.	Description
1	<p>Pump housing: Stainless steel EN 1.4408 ASTM CF8M</p> <p>Wear ring: Stainless steel</p> <p>Flange: Cast iron EN-GJS-500-7 ASTM 70-50-05</p> <p>Impeller: Stainless steel EN 1.4408 ASTM CF8M</p> <p>Internal pump house coating: No coating</p> <p>Shaft: Stainless steel EN 1.4401 AISI 316</p> <p>Installation:</p> <p>Range of ambient temperature: -10 .. 50 °C</p> <p>Maximum operating pressure: 10 bar</p> <p>Pipe connection standard: EN 1092-1</p> <p>Type of inlet connection: DIN</p> <p>Type of outlet connection: DIN</p> <p>Size of inlet connection: DN 200</p> <p>Size of outlet connection: DN 150</p> <p>Pressure rating for connection: PN 10</p> <p>Coupling type: Flexible w/spacer</p> <p>Base frame design: EN/ISO</p> <p>Code for base frame: 9</p> <p>Grouting (Yes/No): N</p> <p>Electrical data:</p> <p>Motor type: SIEMENS</p> <p>Rated power - P2: 45 kW</p> <p>Mains frequency: 50 Hz</p> <p>Rated voltage: 3 x 380-420D/660-725Y V</p> <p>Rated current: 81.0/47.0 A</p> <p>Starting current: 800 %</p> <p>Cos phi - power factor: 0.84</p> <p>Rated speed: 1485 rpm</p> <p>IE efficiency: IE4 95,4%</p> <p>IE Efficiency class: IE4</p> <p>Motor efficiency at full load: 95.4 %</p> <p>Motor efficiency at 3/4 load: 95.7 %</p> <p>Motor efficiency at 1/2 load: 95.4 %</p> <p>Number of poles: 4</p> <p>Enclosure class (IEC 34-5): IP55</p> <p>Insulation class (IEC 85): F</p> <p>Motor No: 92691594</p> <p>Bearing insulation type N-end: CERAMIC SHAFT COATING</p> <p>Others:</p> <p>Minimum efficiency index, MEI ≥: 0.63</p> <p>Net weight: 829 kg</p> <p>Gross weight: 985 kg</p> <p>Shipping volume: 3.09 m³</p> <p>Country of origin: HU</p> <p>Custom tariff no.: 84137059</p> <p>Language on pump nameplate: GB</p>

On request NKE 150-315.2/314 AIA2F1KVSBQQVTW3 50 Hz

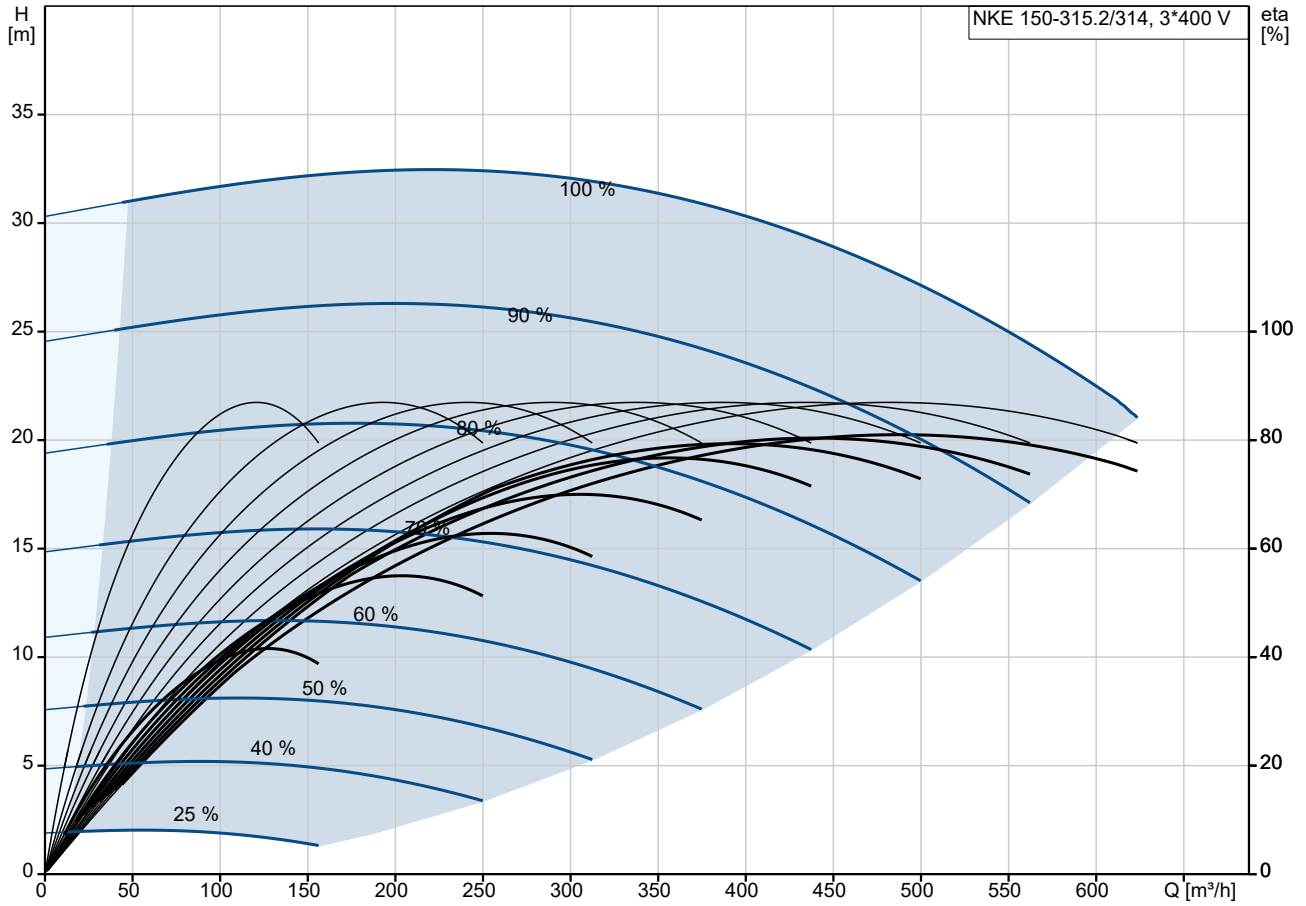

Pumped liquid = Water
Liquid temperature during operation = 20 °C
Density = 998.2 kg/m³

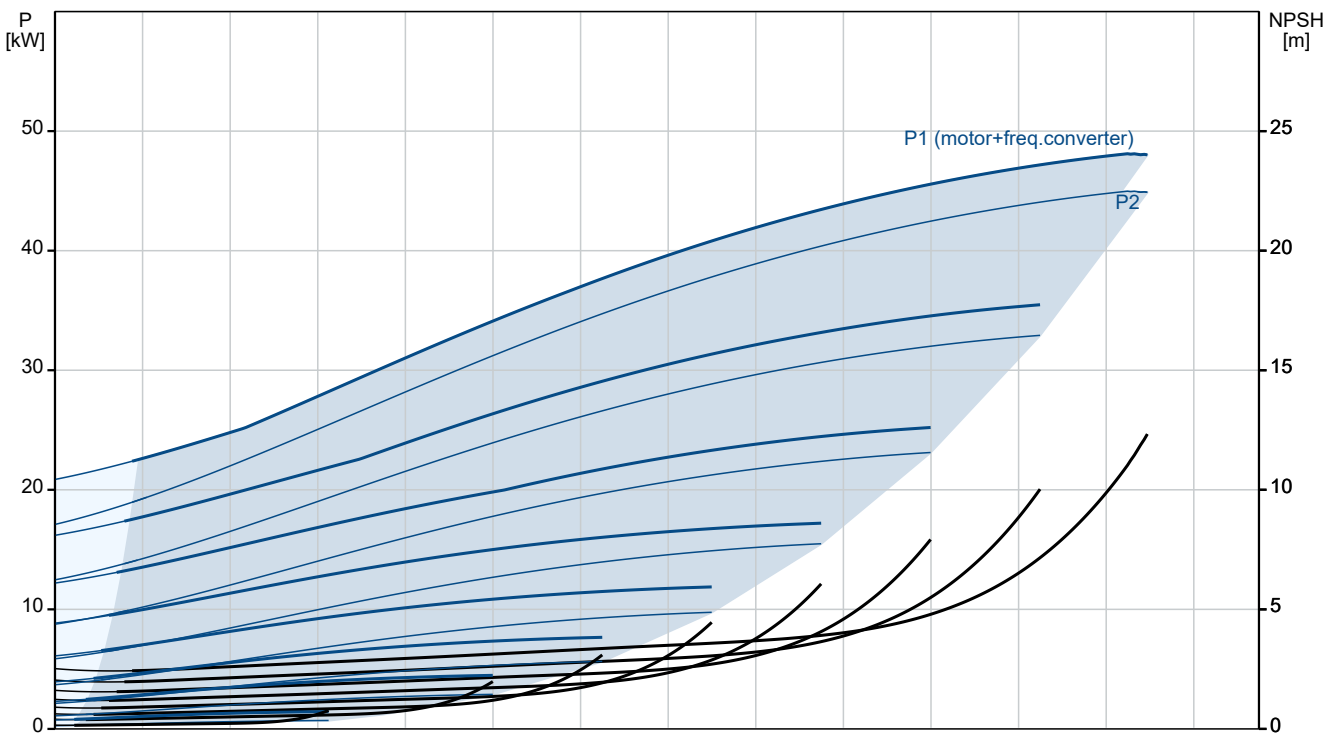

Description	Value
General information:	
Product name:	NKE 150-315.2/314 AIA2F1KVSBQQVTW3
Product No:	On request
EAN number:	On request
Technical:	
Pump speed on which pump data are based:	1485 rpm
Rated flow:	482 m ³ /h
Pump with motor (Yes/No):	Y
Rated head:	27.8 m
Actual impeller diameter:	314 mm
Nominal impeller diameter:	315.2
Shaft diameter:	42 mm
Code for shaft seal:	BQQV
Mechanical seal type:	Single
Curve tolerance:	ISO9906:2012 3B
Pump version:	A2
Bearing design:	Standard
Materials:	
Pump housing:	Stainless steel
Pump housing:	EN 1.4408
Pump housing:	ASTM CF8M
Wear ring:	Stainless steel
Flange:	Cast iron
Flange:	EN-GJS-500-7
Flange:	ASTM 70-50-05
Impeller:	Stainless steel
Impeller:	EN 1.4408
Impeller:	ASTM CF8M
Internal pump house coating:	No coating
Material code:	K
Code for rubber:	V
Shaft:	Stainless steel
Shaft:	EN 1.4401
Shaft:	AISI 316
Installation:	
Range of ambient temperature:	-10 .. 50 °C
Maximum operating pressure:	10 bar
Pipe connection standard:	EN 1092-1
Type of inlet connection:	DIN
Type of outlet connection:	DIN
Size of inlet connection:	DN 200
Size of outlet connection:	DN 150
Pressure rating for connection:	PN 10
Coupling type:	Flexible w/spacer
Base frame design:	EN/ISO
Code for base frame:	9
Grouting (Yes/No):	N
Connect code:	F
Liquid:	
Pumped liquid:	Water
Liquid temperature range:	-10 .. 90 °C
Selected liquid temperature:	20 °C
Density:	998.2 kg/m ³
Electrical data:	
Motor type:	SIEMENS
Rated power - P2:	45 kW

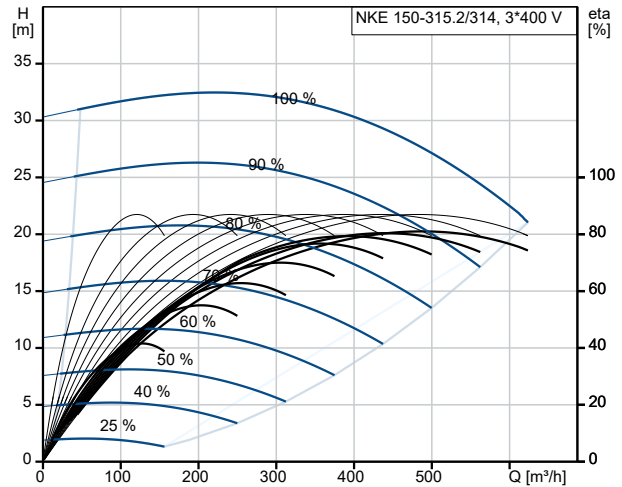

Pumped liquid = Water
Liquid temperature during operation = 20 °C
Density = 998.2 kg/m³

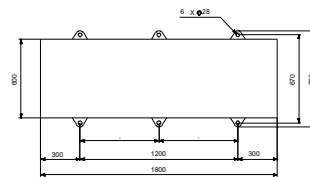
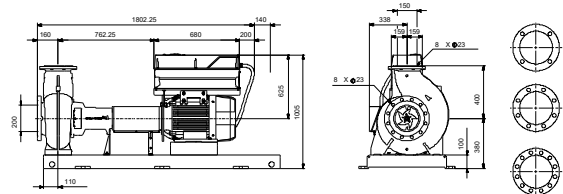
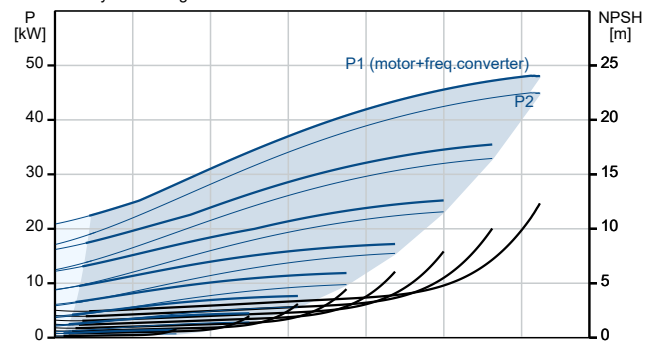



Company name:

Created by:

Phone:

Date:

22/10/2024

Description	Value
Mains frequency:	50 Hz
Rated voltage:	3 x 380-420D/660-725Y V
Rated current:	81.0/47.0 A
Starting current:	800 %
Cos phi - power factor:	0.84
Rated speed:	1485 rpm
IE efficiency:	IE4 95,4%
IE Efficiency class:	IE4
Motor efficiency at full load:	95.4 %
Motor efficiency at 3/4 load:	95.7 %
Motor efficiency at 1/2 load:	95.4 %
Number of poles:	4
Enclosure class (IEC 34-5):	IP55
Insulation class (IEC 85):	F
Built-in motor protection:	PTC
Motor No:	92691594
Bearing insulation type N-end:	CERAMIC SHAFT COATING
Controls:	
VFD product number:	99616825
Frequency converter:	Built-in
Type of frequency converter:	CUE 3X380-500V IP55 RUG 45KW
Appr. for VFD:	CE, CULUS, C-TICK
Pressure sensor:	N
Others:	
Minimum efficiency index, MEI ≥:	0.63
Net weight:	829 kg
Gross weight:	985 kg
Shipping volume:	3.09 m ³
Country of origin:	HU
Custom tariff no.:	84137059
Language on pump nameplate:	GB

On request NKE 150-315.2/314 AIA2F1KVSBQQVTW3 50 Hz

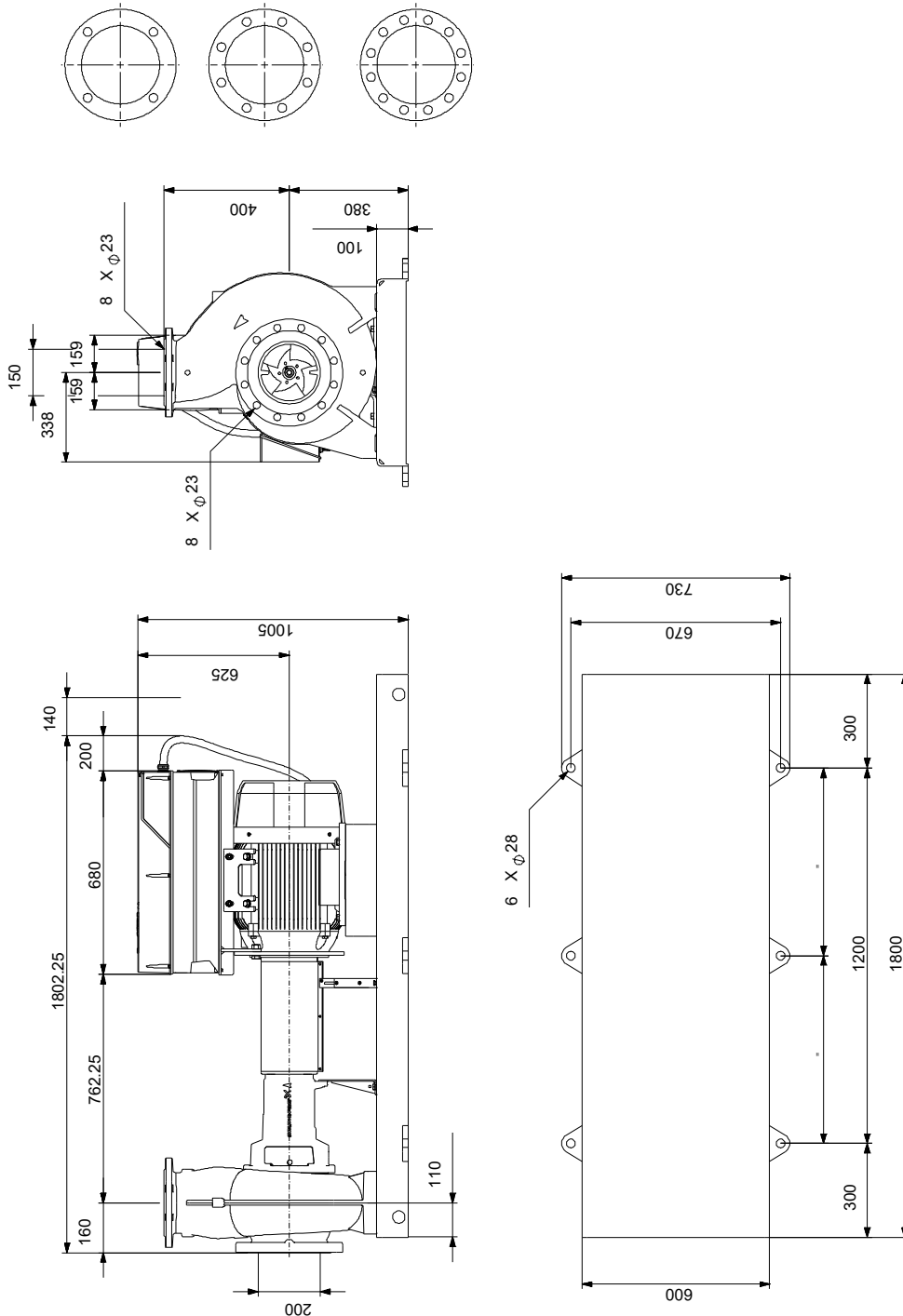

Note! All units are in [mm] unless others are stated.

Disclaimer: This simplified dimensional drawing does not show all details.

On request NKE 150-315.2/314 AIA2F1KVSBQQVTW3 50 Hz



IEC TP211 THERMALLY PROTECTED WHEN THE THERMISTORS ARE
CONNECTED TO AMPLIFIER RELAY FOR CONTROL OF MAIN SUPPLY
THERMISTORS PTC ACCORDING TO DIN 44082

Note! All units are in [mm] unless others are stated.

