

Qty. Description

1 UNILIFT AP35.40.08.3V



Note! Product picture may differ from actual product

Product No.: On request
Submersible drainage pump type

Vertical single-stage stainless steel submersible pump with vertical discharge port and integrated submersible 3-phase totally enclosed motor in insulation class F. The pump is fitted with a suction strainer.

The impeller is a VORTEX impeller for 35 mm free passage suitable for pumping groundwater, surface water, rain water and similar.

The pump has a double shaft seal and an intermediate oil chamber pre-filled with non-toxic special oil.

The pump has a riser pipe, a cooling jacket for continuous cooling of the motor by the pumped liquid and long-life deep-groove greased-for-life ball bearings.

The pump is ready for use as it is fitted with carrying handle and is supplied with a 10 m mains cable. The mains cable is of the plug type with glass sealing compound in the socket to prevent penetration of humidity into the stator windings.

Liquid:
Liquid temperature range: 0 .. 55 °C
Density: 998.2 kg/m³

Technical:
Maximum flow: 5 l/s
Type of impeller: VORTEX
Max. Particle: 35 mm
Approvals: CE,RCM,VDE,LGABG,EAC,TUVRHWID,MORO,UKCA,CNROHSEXP,SEPRO

Materials:
Pump housing: Stainless steel
EN 1.4301
AISI 304
Impeller: Stainless steel
EN 1.4301

Qty. Description

1	<p>AISI 304</p> <p>Cable union: Brass CW602N C35330</p> <p>Installation:</p> <p>Range of ambient temperature: 0 .. 55 °C</p> <p>Type of connection: Rp</p> <p>Size of connection: 1 1/2 inch</p> <p>Maximum installation depth: 7 m</p> <p>Place of installation: Indoor/outdoor</p> <p>Electrical data:</p> <p>Power input P1: 1.2 kW</p> <p>Rated power - P2: 0.7 kW</p> <p>Mains frequency: 50 Hz</p> <p>Rated voltage: 3 x 400 V</p> <p>Rated current: 2 A</p> <p>Cos phi - power factor: 0.86</p> <p>Rated speed: 2820 rpm</p> <p>Enclosure class (IEC 34-5): IP68</p> <p>Insulation class (IEC 85): F</p> <p>Length of power cable: 10 m</p> <p>Type of cable plug: NONE</p> <p>Others:</p> <p>Net weight: 14.1 kg</p> <p>Gross weight: 14.8 kg</p> <p>Danish VVS No.: 391318131</p> <p>Swedish RSK No.: 5880118</p> <p>Finnish LVI No.: 4822583</p> <p>Country of origin: HU</p> <p>Custom tariff no.: 84137021</p> <p>Environmental approvals: WEEE</p>
---	---

On request UNILIFT AP35.40.08.3V 50 Hz

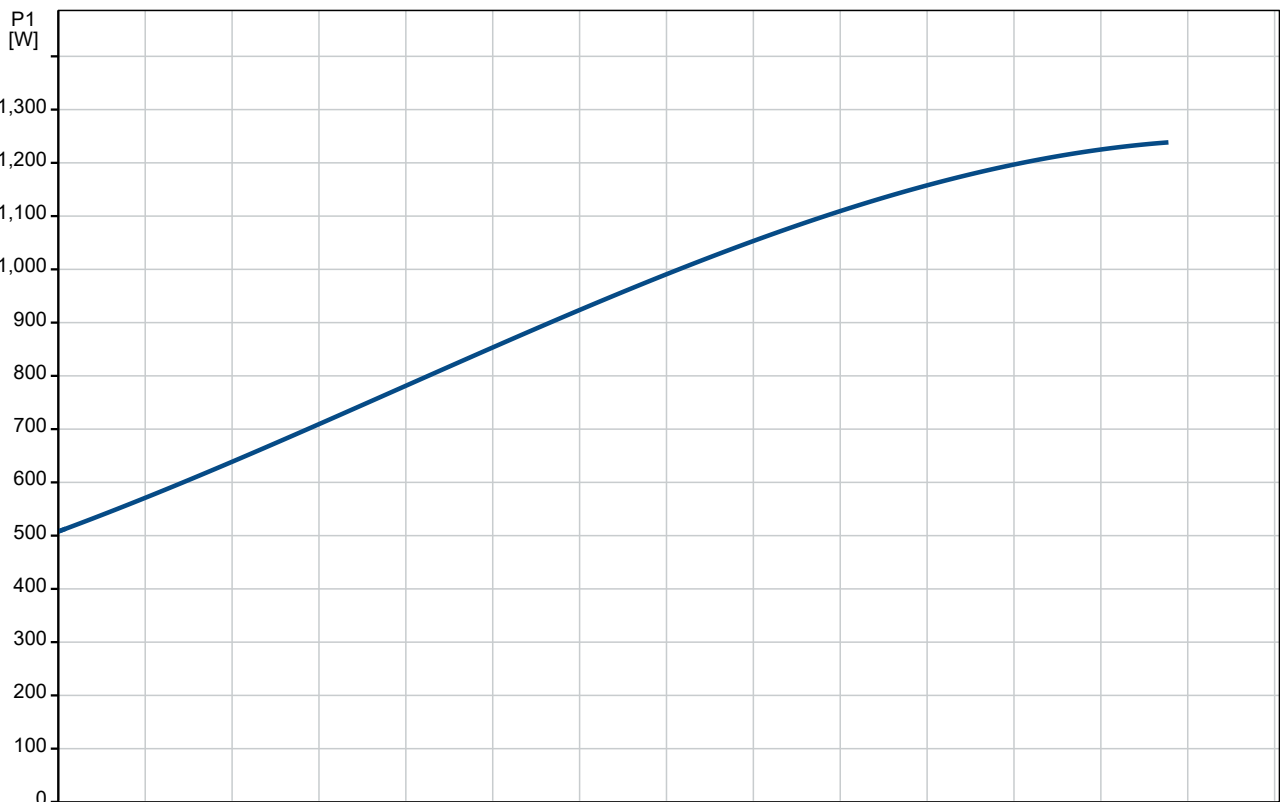
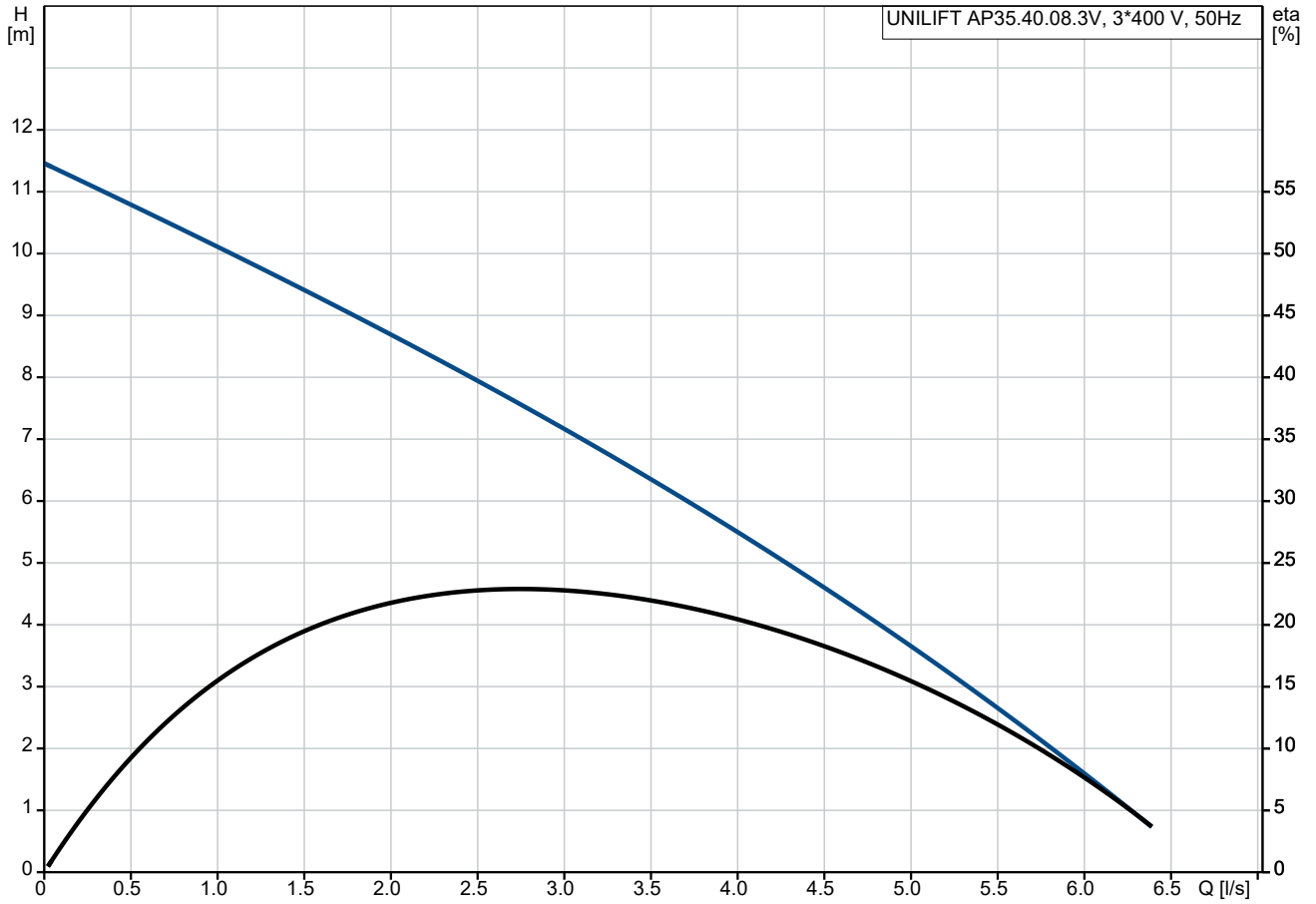

Description	Value
General information:	
Product name:	UNILIFT AP35.40.08.3V
Product No:	On request
EAN number:	On request
Technical:	
Maximum flow:	5 l/s
Maximum head:	11 m
Type of impeller:	VORTEX
Max. Particle:	35 mm
Approvals:	CE,RCM,VDE,LGABG,EAC,TUV RHWID,MORO,UKCA,CNROHSE XP,SEPRO
Materials:	
Pump housing:	Stainless steel
Pump housing:	EN 1.4301
Pump housing:	AISI 304
Impeller:	Stainless steel
Impeller:	EN 1.4301
Impeller:	AISI 304
Cable union:	Brass
Cable union:	CW602N
Cable union:	C35330
Installation:	
Range of ambient temperature:	0 .. 55 °C
Type of connection:	Rp
Size of connection:	1 1/2 inch
Maximum installation depth:	7 m
Inst dry/wet:	D/S
Installation:	horizontal or vertical
Place of installation:	Indoor/outdoor
Liquid:	
Liquid temperature range:	0 .. 55 °C
Density:	998.2 kg/m ³
Electrical data:	
Power input P1:	1.2 kW
Rated power - P2:	0.7 kW
Mains frequency:	50 Hz
Rated voltage:	3 x 400 V
Rated current:	2 A
Cos phi - power factor:	0.86
Rated speed:	2820 rpm
Enclosure class (IEC 34-5):	IP68
Insulation class (IEC 85):	F
Built-in motor protection:	NONE
Thermal protec:	external
Length of power cable:	10 m
Type of cable plug:	NONE
Others:	
Net weight:	14.1 kg
Gross weight:	14.8 kg
Danish VVS No.:	391318131
Swedish RSK No.:	5880118
Finnish LVI No.:	4822583
Country of origin:	HU
Custom tariff no.:	84137021
Environmental approvals:	WEEE

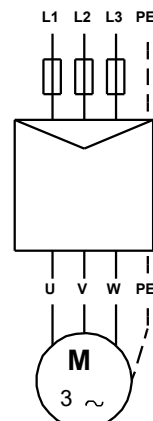
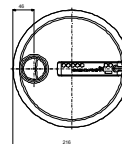
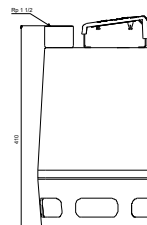
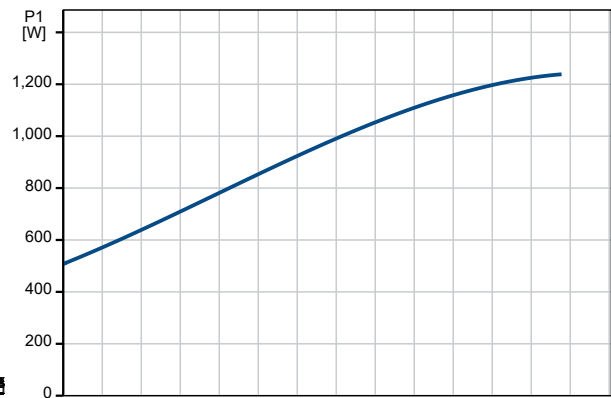
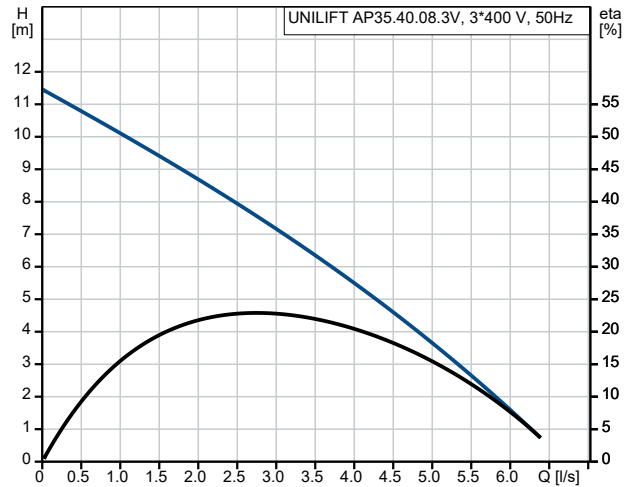

On request UNILIFT AP35.40.08.3V 50 Hz

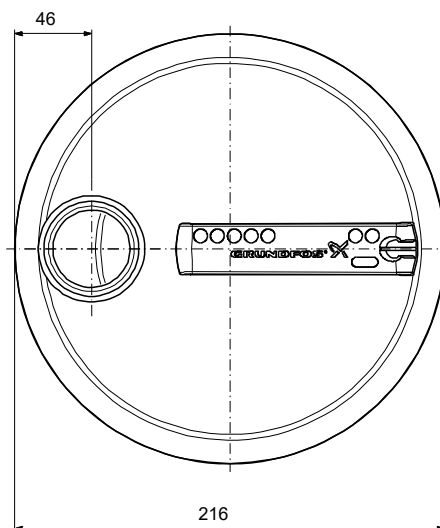
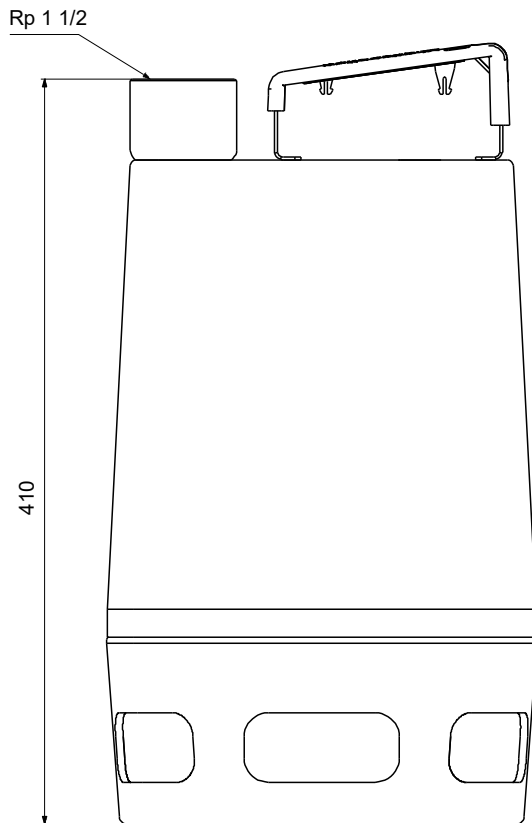

Note! All units are in [mm] unless others are stated.
Disclaimer: This simplified dimensional drawing does not show all details.

