

Qty. Description

1 UNILIFT AP50.50.08.1V



Note! Product picture may differ from actual product

Product No.: On request
Submersible drainage pump type

Vertical single-stage stainless steel submersible pump with vertical discharge port and integrated submersible 1-phase totally enclosed motor in insulation class F with thermal overload protection. The pump is fitted with a suction strainer.

The impeller is a VORTEX impeller for 50 mm free passage suitable for pumping groundwater, surface water, rain water and similar.

The pump has a double shaft seal and an intermediate oil chamber pre-filled with non-toxic special oil.

The pump has a riser pipe, a cooling jacket for continuous cooling of the motor by the pumped liquid and long-life deep-groove greased-for-life ball bearings.

The pump is ready for use as it is fitted with carrying handle and is supplied with a 10 m mains cable. The mains cable is of the plug type with glass sealing compound in the socket to prevent penetration of humidity into the stator windings.

Liquid:
Liquid temperature range: 0 .. 55 °C
Density: 998.2 kg/m³

Technical:
Maximum flow: 6.94 l/s
Type of impeller: VORTEX
Max. Particle: 50 mm
Approvals: CE,RCM,VDE,LGABG,EAC,TUVRHWID,MORO,UKCA,SEPRO

Materials:
Pump housing: Stainless steel
EN 1.4301
AISI 304

Impeller: Stainless steel

Qty. Description

1	<p>EN 1.4301 AISI 304 Cable union: Brass CW602N C35330</p> <p>Installation: Range of ambient temperature: 0 .. 55 °C Type of connection: Rp Size of connection: 2 inch Maximum installation depth: 7 m Place of installation: Indoor/outdoor</p> <p>Electrical data: Power input P1: 1.3 kW Motor type 1-phase: PSC Rated power - P2: 0.8 kW Mains frequency: 50 Hz Rated voltage: 1 x 230 V Rated current: 5.9 A Cos phi - power factor: 0.99 Rated speed: 2790 rpm Capacitor size - run: 16 µF/400 V Enclosure class (IEC 34-5): IP68 Insulation class (IEC 85): F Length of power cable: 10 m Type of cable plug: SCHUKO</p> <p>Others: Net weight: 17.3 kg Gross weight: 18 kg Danish VVS No.: 391321112 Swedish RSK No.: 5885794 Finnish LVI No.: 4822573 Norwegian NRF no.: 9045683 Country of origin: HU Custom tariff no.: 84137021 Environmental approvals: WEEE</p>
---	---

On request UNILIFT AP50.50.08.1V 50 Hz

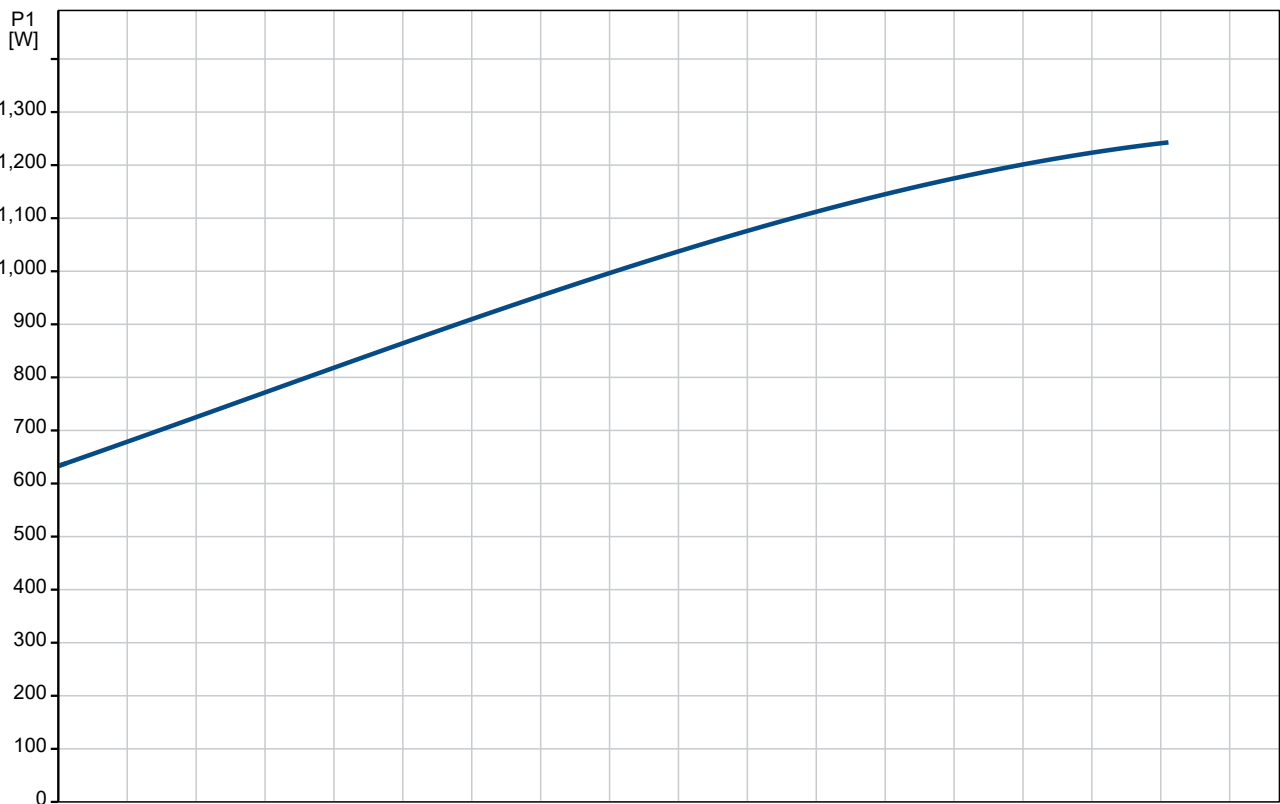
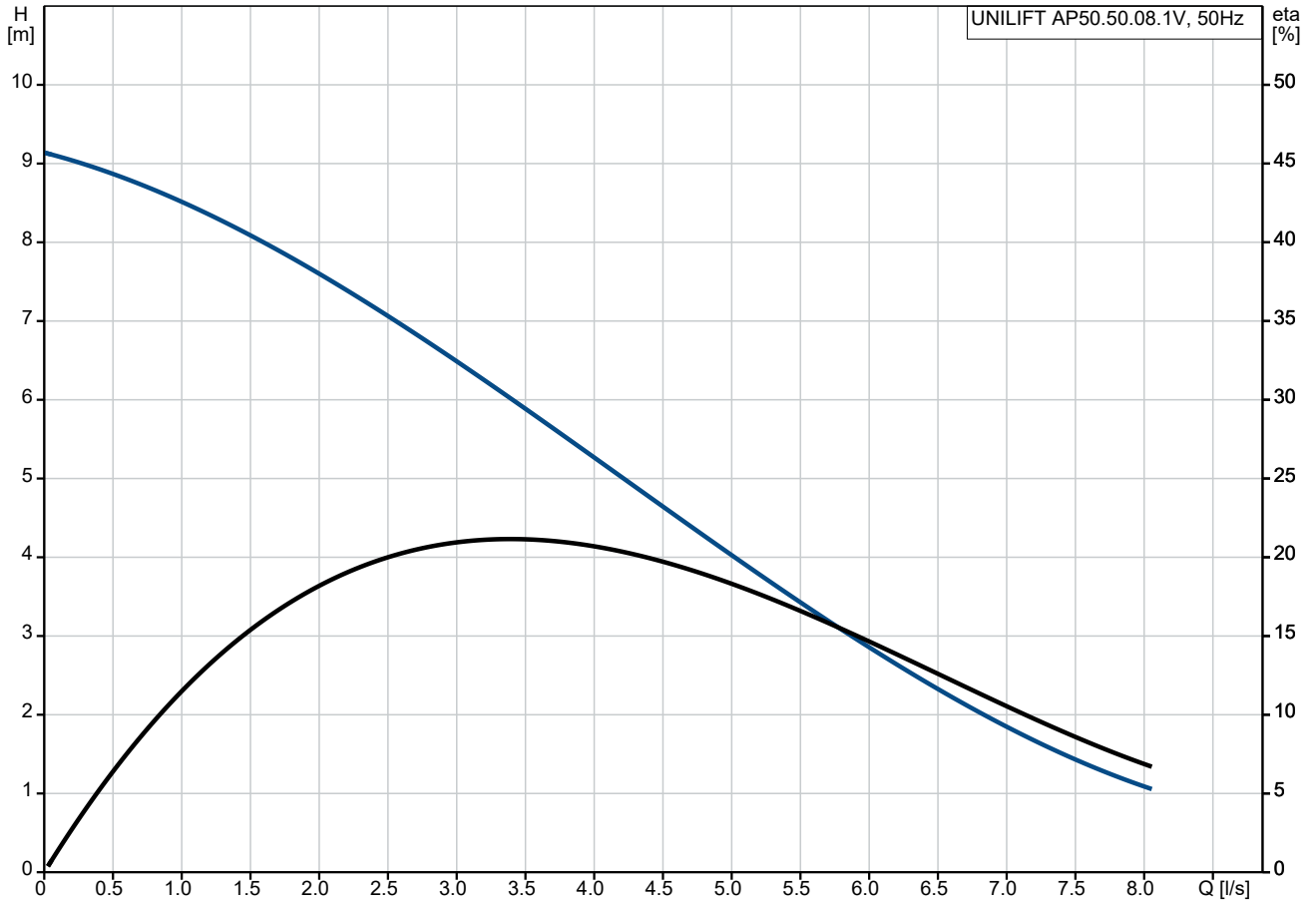

Description	Value
General information:	
Product name:	UNILIFT AP50.50.08.1V
Product No:	On request
EAN number:	On request
Technical:	
Maximum flow:	6.94 l/s
Maximum head:	9 m
Type of impeller:	VORTEX
Max. Particle:	50 mm
Approvals:	CE,RCM,VDE,LGABG,EAC,TUV RHWID,MORO,UKCA,SEPRO
Materials:	
Pump housing:	Stainless steel
Pump housing:	EN 1.4301
Pump housing:	AISI 304
Impeller:	Stainless steel
Impeller:	EN 1.4301
Impeller:	AISI 304
Cable union:	Brass
Cable union:	CW602N
Cable union:	C35330
Installation:	
Range of ambient temperature:	0 .. 55 °C
Type of connection:	Rp
Size of connection:	2 inch
Maximum installation depth:	7 m
Inst dry/wet:	D/S
Installation:	horizontal or vertical
Place of installation:	Indoor/outdoor
Liquid:	
Liquid temperature range:	0 .. 55 °C
Density:	998.2 kg/m ³
Electrical data:	
Power input P1:	1.3 kW
Motor type 1-phase:	PSC
Rated power - P2:	0.8 kW
Mains frequency:	50 Hz
Rated voltage:	1 x 230 V
Rated current:	5.9 A
Cos phi - power factor:	0.99
Rated speed:	2790 rpm
Capacitor size - run:	16 µF/400 V
Enclosure class (IEC 34-5):	IP68
Insulation class (IEC 85):	F
Built-in motor protection:	CONTACT
Thermal protec:	internal
Length of power cable:	10 m
Type of cable plug:	SCHUKO
Others:	
Net weight:	17.3 kg
Gross weight:	18 kg
Danish VVS No.:	391321112
Swedish RSK No.:	5885794
Finnish LVI No.:	4822573
Norwegian NRF no.:	9045683
Country of origin:	HU
Custom tariff no.:	84137021
Environmental approvals:	WEEE

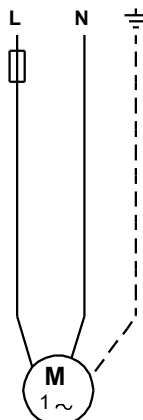
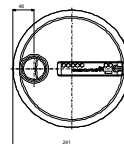
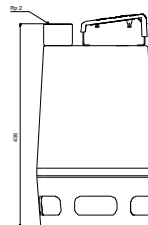
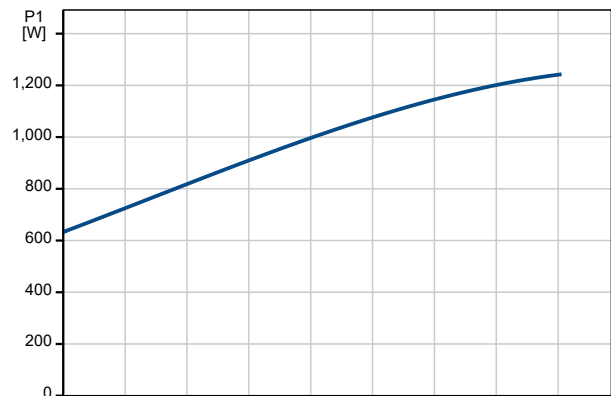
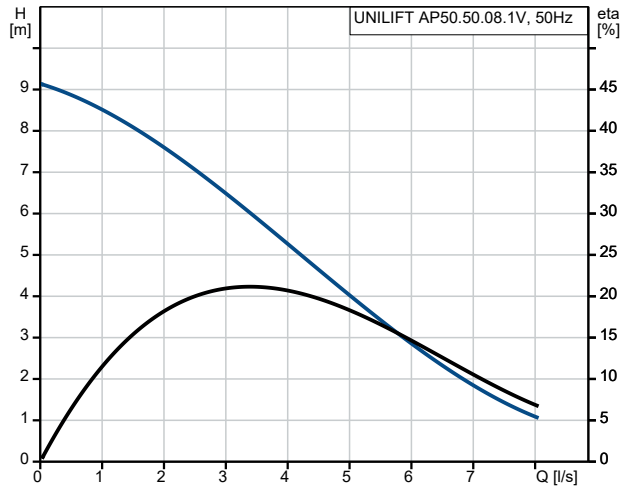

On request UNILIFT AP50.50.08.1V 50 Hz

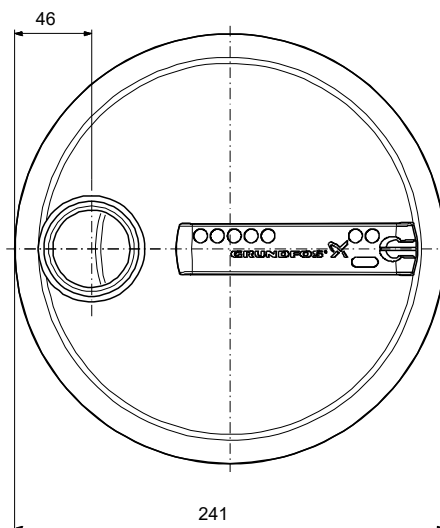
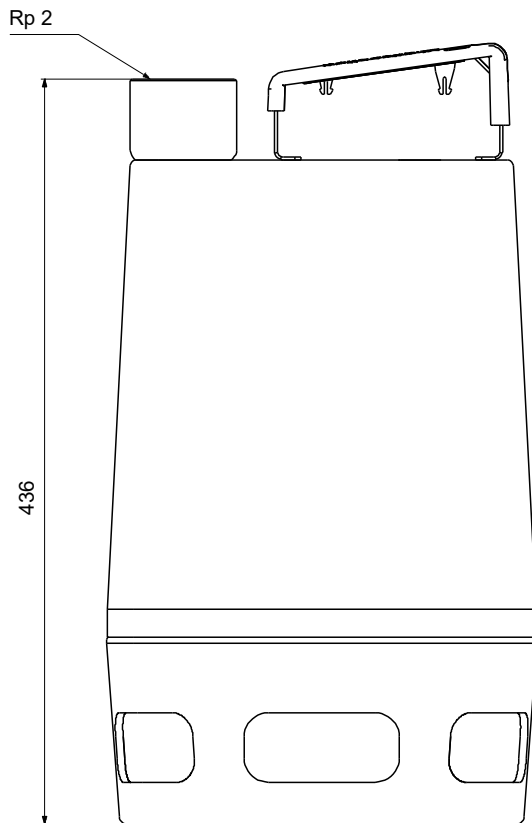

Note! All units are in [mm] unless others are stated.
Disclaimer: This simplified dimensional drawing does not show all details.

