

**Qty. Description**

1 UNILIFT AP35.40.08.A1V



**Note! Product picture may differ from actual product**

Product No.: On request  
Submersible drainage pump type

Vertical single-stage stainless steel submersible pump with vertical discharge port and integrated submersible 1-phase totally enclosed motor in insulation class F with thermal overload protection.

The pump is fitted with suction strainer and level switch for automatic start and stop.

The impeller is a VORTEX impeller for 35 mm free passage suitable for pumping groundwater, surface water, rain water and similar.

The pump has a double shaft seal and an intermediate oil chamber pre-filled with non-toxic special oil.

The pump has a riser pipe, a cooling jacket for continuous cooling of the motor by the pumped liquid and long-life deep-groove greased-for-life ball bearings.

The pump is ready for use as it is fitted with carrying handle and is supplied with a 10 m mains cable. The mains cable is of the plug type with glass sealing compound in the socket to prevent penetration of humidity into the stator windings.

Liquid:  
Liquid temperature range: 0 .. 55 °C  
Density: 998.2 kg/m<sup>3</sup>

Technical:  
Maximum flow: 5 l/s  
Type of impeller: VORTEX  
Max. Particle: 35 mm  
Approvals: CE,RCM,VDE,LGABG,EAC,TUVRHWID,MORO,UKCA,SEPRO

Materials:  
Pump housing: Stainless steel  
EN 1.4301

Qty.	Description
1	<p>AISI 304                      Impeller: Stainless steel                      EN 1.4301                      AISI 304                      Cable union: Brass                      CW602N                      C35330</p> <p>Installation:                      Range of ambient temperature: 0 .. 55 °C                      Type of connection: Rp                      Size of connection: 1 1/2 inch                      Maximum installation depth: 7 m                      Place of installation: Indoor/outdoor</p> <p>Electrical data:                      Power input P1: 1.2 kW                      Motor type 1-phase: PSC                      Rated power - P2: 0.7 kW                      Mains frequency: 50 Hz                      Rated voltage: 1 x 230 V                      Rated current: 5.5 A                      Cos phi - power factor: 0.98                      Rated speed: 2795 rpm                      Capacitor size - run: 16 µF/400 V                      Enclosure class (IEC 34-5): IP68                      Insulation class (IEC 85): F                      Length of power cable: 10 m                      Type of cable plug: SCHUKO</p> <p>Others:                      Net weight: 13.9 kg                      Gross weight: 15.2 kg                      Danish VVS No.: 391317331                      Swedish RSK No.: 5885789                      Finnish LVI No.: 4822570                      Norwegian NRF no.: 9045649                      Country of origin: HU                      Custom tariff no.: 84137021                      Environmental approvals: WEEE</p>

## On request UNILIFT AP35.40.08.A1V 50 Hz

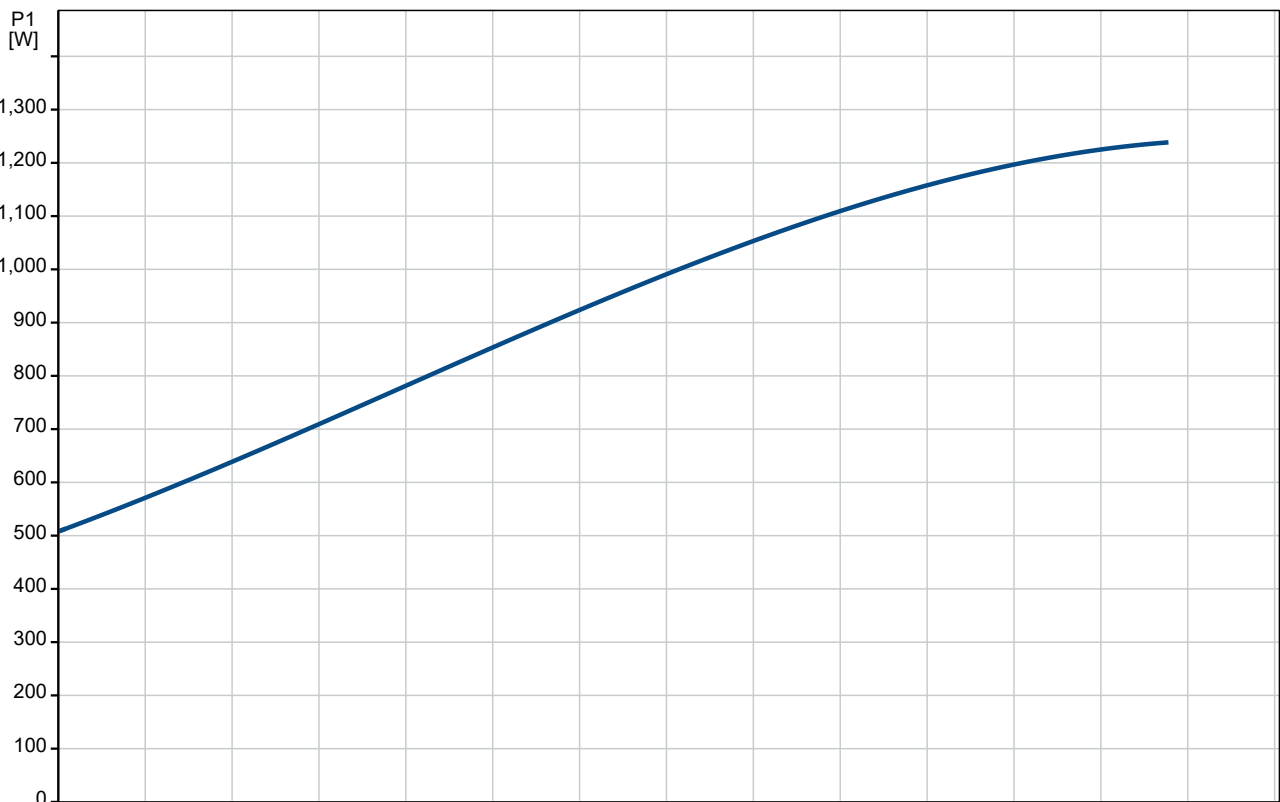
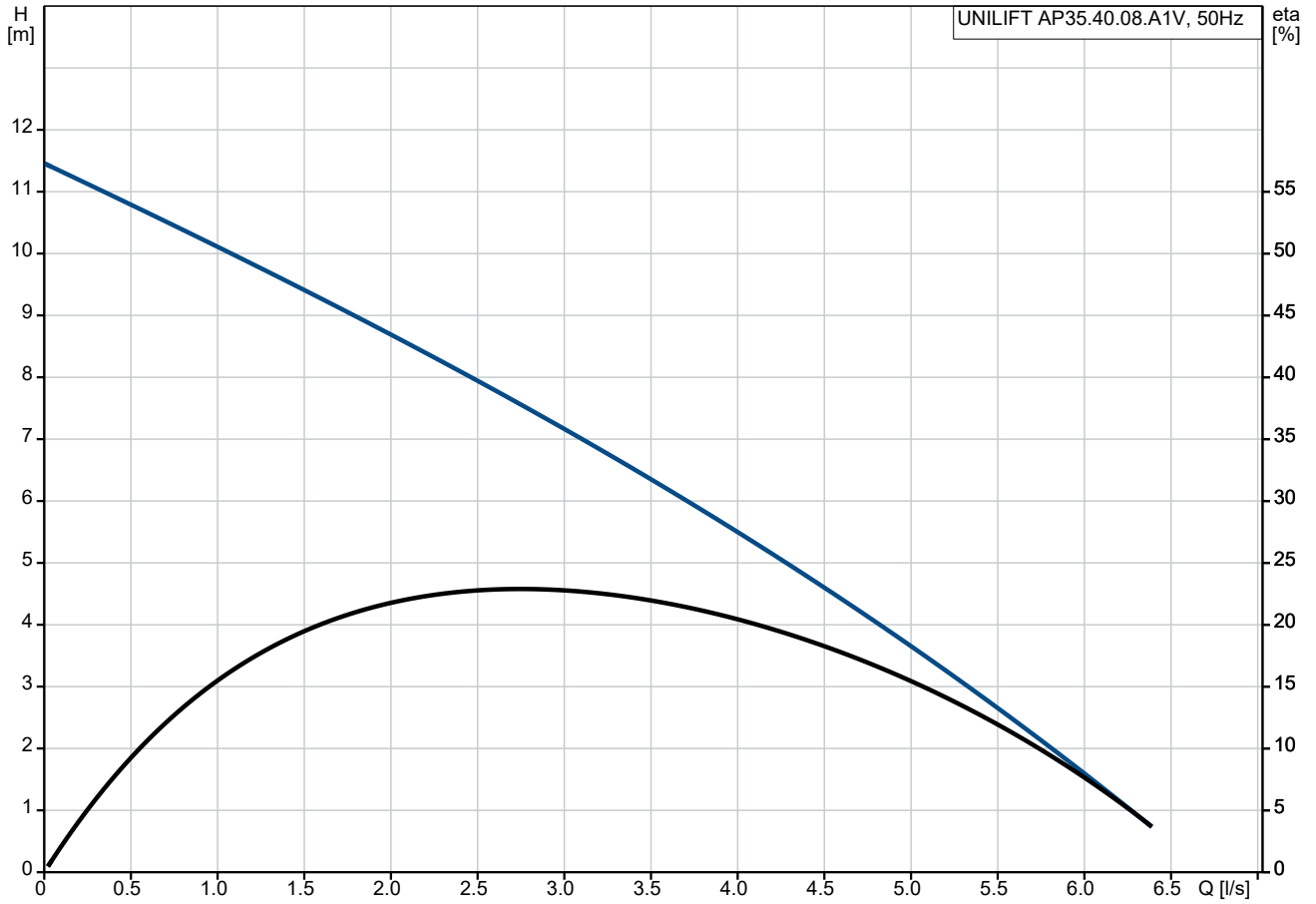

Description	Value
<b>General information:</b>	
Product name:	UNILIFT AP35.40.08.A1V
Product No:	On request
EAN number:	On request
<b>Technical:</b>	
Maximum flow:	5 l/s
Maximum head:	11 m
Type of impeller:	VORTEX
Max. Particle:	35 mm
Approvals:	CE,RCM,VDE,LGABG,EAC,TUV RHWID,MORO,UKCA,SEPRO
<b>Materials:</b>	
Pump housing:	Stainless steel
Pump housing:	EN 1.4301
Pump housing:	AISI 304
Impeller:	Stainless steel
Impeller:	EN 1.4301
Impeller:	AISI 304
Cable union:	Brass
Cable union:	CW602N
Cable union:	C35330
<b>Installation:</b>	
Range of ambient temperature:	0 .. 55 °C
Type of connection:	Rp
Size of connection:	1 1/2 inch
Maximum installation depth:	7 m
Inst dry/wet:	D/S
Installation:	horizontal or vertical
Place of installation:	Indoor/outdoor
<b>Liquid:</b>	
Liquid temperature range:	0 .. 55 °C
Density:	998.2 kg/m <sup>3</sup>
<b>Electrical data:</b>	
Power input P1:	1.2 kW
Motor type 1-phase:	PSC
Rated power - P2:	0.7 kW
Mains frequency:	50 Hz
Rated voltage:	1 x 230 V
Rated current:	5.5 A
Cos phi - power factor:	0.98
Rated speed:	2795 rpm
Capacitor size - run:	16 µF/400 V
Enclosure class (IEC 34-5):	IP68
Insulation class (IEC 85):	F
Built-in motor protection:	CONTACT
Thermal protec:	internal
Length of power cable:	10 m
Type of cable plug:	SCHUKO
<b>Controls:</b>	
Level switch:	float switch
<b>Others:</b>	
Net weight:	13.9 kg
Gross weight:	15.2 kg
Danish VVS No.:	391317331
Swedish RSK No.:	5885789
Finnish LVI No.:	4822570
Norwegian NRF no.:	9045649
Country of origin:	HU

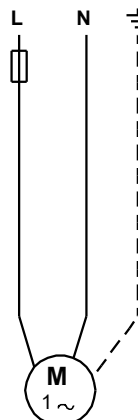
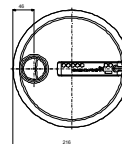
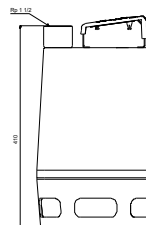
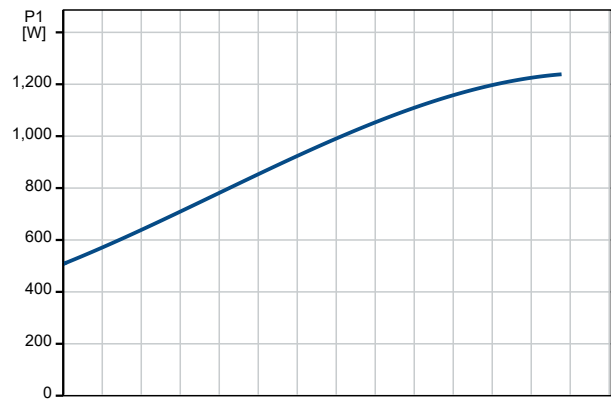
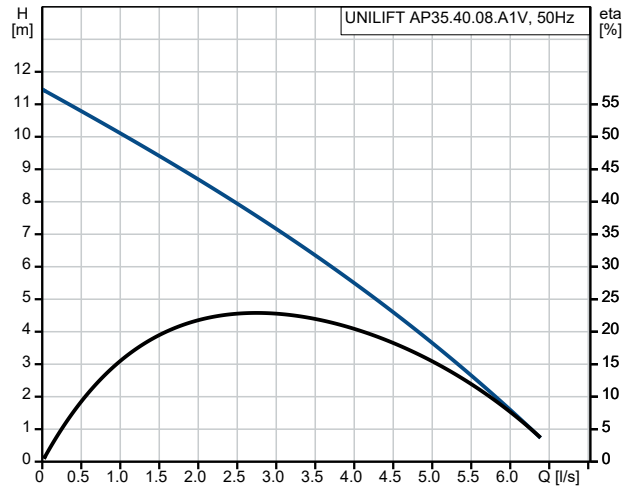



Company name:

Created by:

Phone:

Date:

29/11/2023

Description	Value
Custom tariff no.:	84137021
Environmental approvals:	WEEE

**On request UNILIFT AP35.40.08.A1V 50 Hz**

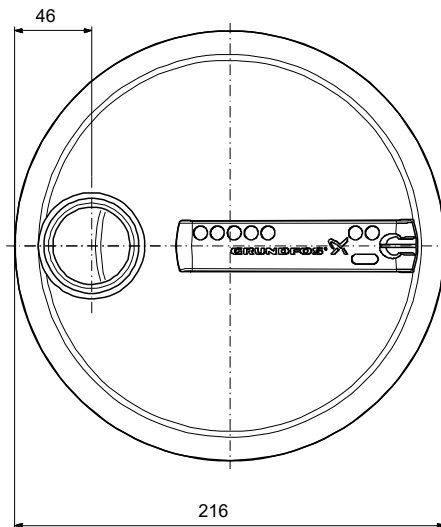
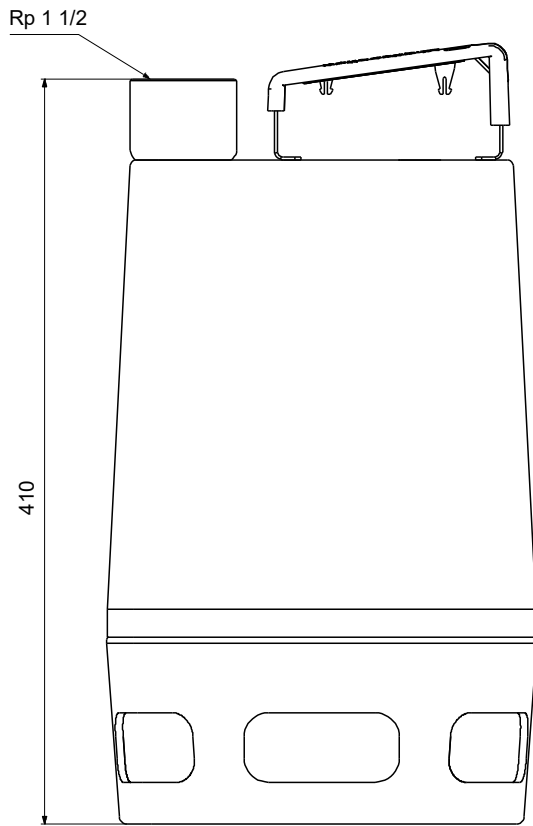

Note! All units are in [mm] unless others are stated.  
Disclaimer: This simplified dimensional drawing does not show all details.

