

Qty. Description

1 UNILIFT AP35.40.08.A3V



Note! Product picture may differ from actual product

Product No.: On request
Submersible drainage pump type

Vertical single-stage stainless steel submersible pump with vertical discharge port and integrated submersible 3-phase totally enclosed motor in insulation class F. The pump is fitted with a suction strainer.

The pump is supplied with a control box including motor starter, a motor protection and a float switch for automatic start/stop of the pump . The float switch contains 10 m cable. And there is a 0.8m main cable connected to the box (see electrical data for optional CEE plug).

The impeller is a VORTEX impeller for 35 mm free passage suitable for pumping groundwater, surface water, rain water and similar liquids.

The pump has a double shaft seal and an intermediate oil chamber pre-filled with non-toxic special oil.

The pump has a riser pipe, a cooling jacket for continuous cooling of the motor by the pumped liquid and long-life deep-groove greased-for-life ball bearings.

The pump is ready for use as it is fitted with carrying handle and is supplied with a 10 m mains cable. The mains cable is of the plug type with glass sealing compound in the socket to prevent penetration of humidity into the stator windings.

Liquid:
Liquid temperature range: 0 .. 55 °C
Density: 998.2 kg/m³

Technical:
Maximum flow: 5 l/s
Type of impeller: VORTEX
Max. Particle: 35 mm
Approvals: CE,RCM,LGABG,EAC,TUVRHWID,MORO,UKCA,SEPRO

On request UNILIFT AP35.40.08.A3V 50 Hz

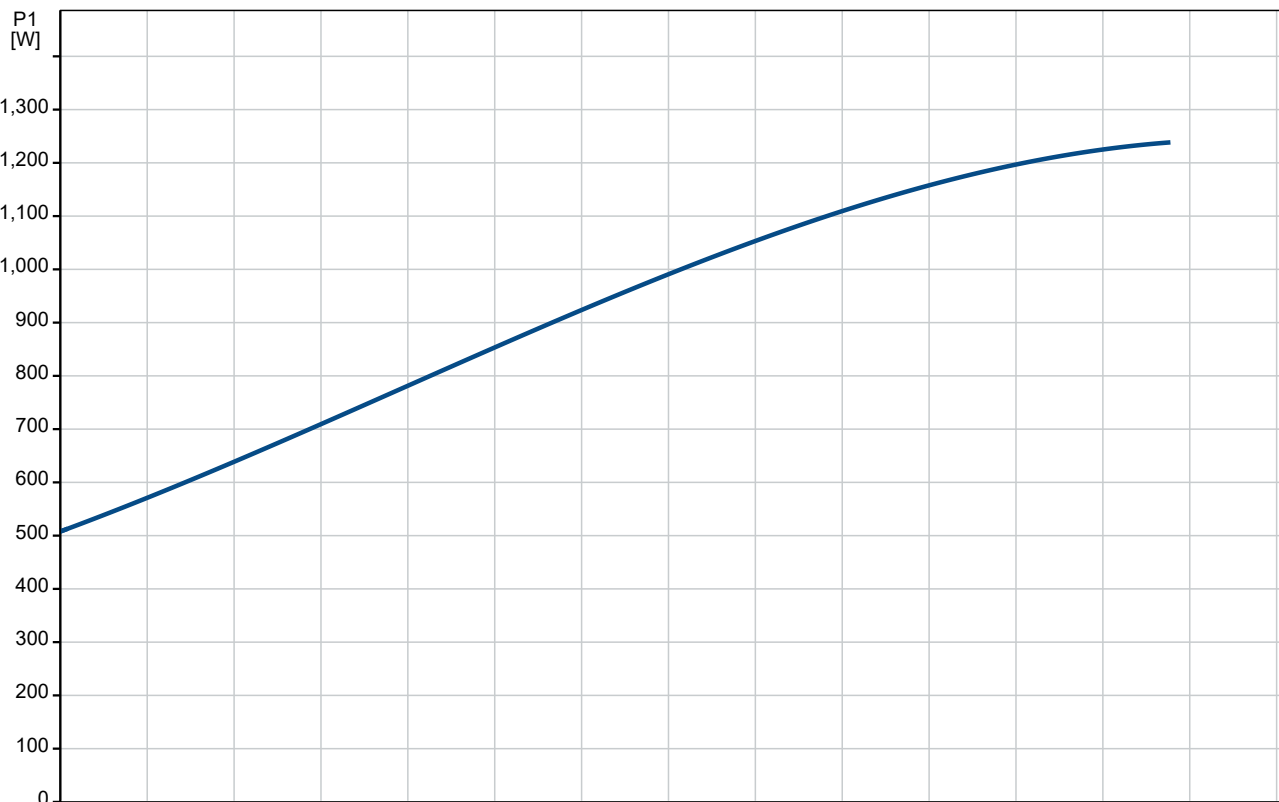
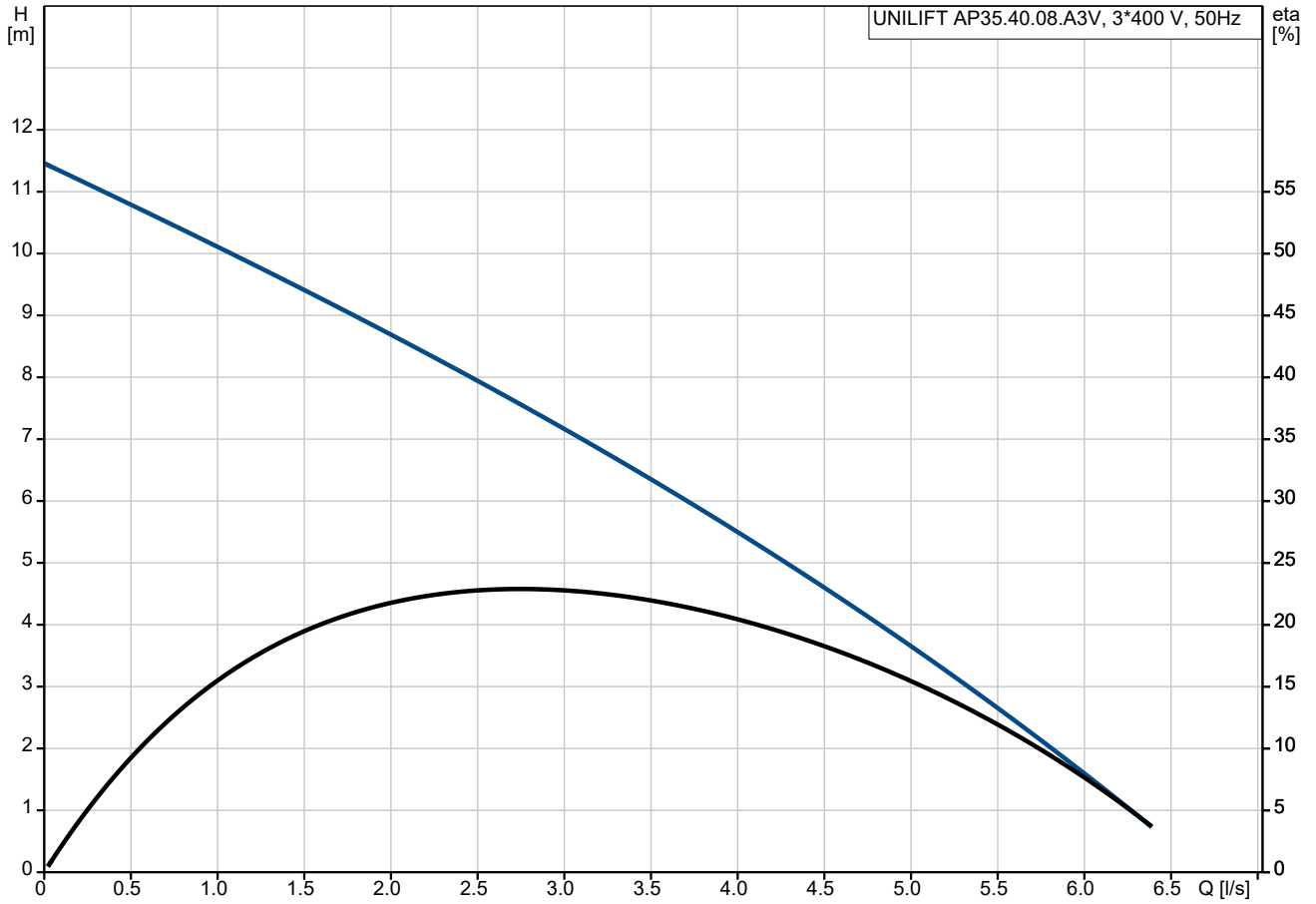

Description	Value
General information:	
Product name:	UNILIFT AP35.40.08.A3V
Product No:	On request
EAN number:	On request
Technical:	
Maximum flow:	5 l/s
Maximum head:	11 m
Type of impeller:	VORTEX
Max. Particle:	35 mm
Approvals:	CE,RCM,LGABG,EAC,TUVRHWD,MORO,UKCA,SEPRO
Materials:	
Pump housing:	Stainless steel
Pump housing:	EN 1.4301
Pump housing:	AISI 304
Impeller:	Stainless steel
Impeller:	EN 1.4301
Impeller:	AISI 304
Cable union:	Brass
Cable union:	CW602N
Cable union:	C35330
Installation:	
Range of ambient temperature:	0 .. 55 °C
Type of connection:	Rp
Size of connection:	1 1/2 inch
Maximum installation depth:	7 m
Inst dry/wet:	D/S
Installation:	horizontal or vertical
Place of installation:	Indoor/outdoor
Liquid:	
Liquid temperature range:	0 .. 55 °C
Density:	998.2 kg/m ³
Electrical data:	
Power input P1:	1.2 kW
Rated power - P2:	0.7 kW
Mains frequency:	50 Hz
Rated voltage:	3 x 400 V
Rated current:	2 A
Cos phi - power factor:	0.86
Rated speed:	2820 rpm
Enclosure class (IEC 34-5):	IP68
Insulation class (IEC 85):	F
Built-in motor protection:	NONE
Thermal protec:	external
Length of power cable:	10 m
Type of cable plug:	CEE
Controls:	
Level switch:	float switch
Others:	
Net weight:	17.2 kg
Gross weight:	18.7 kg
Country of origin:	HU
Custom tariff no.:	84137021
Environmental approvals:	WEEE

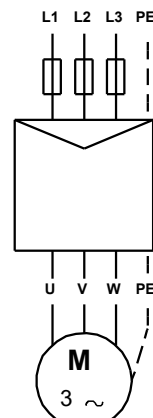
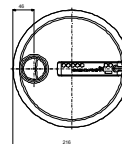
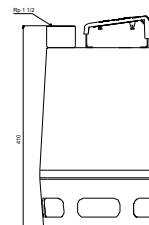
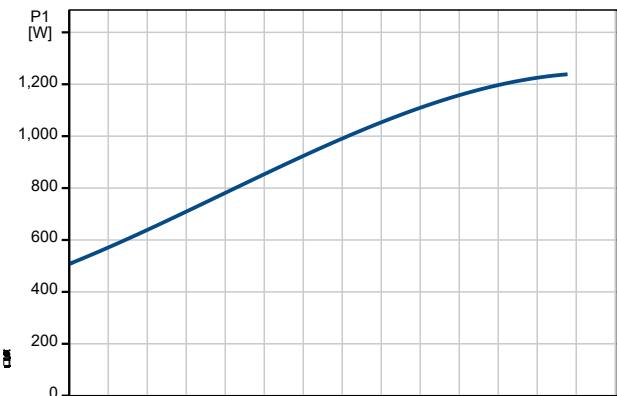
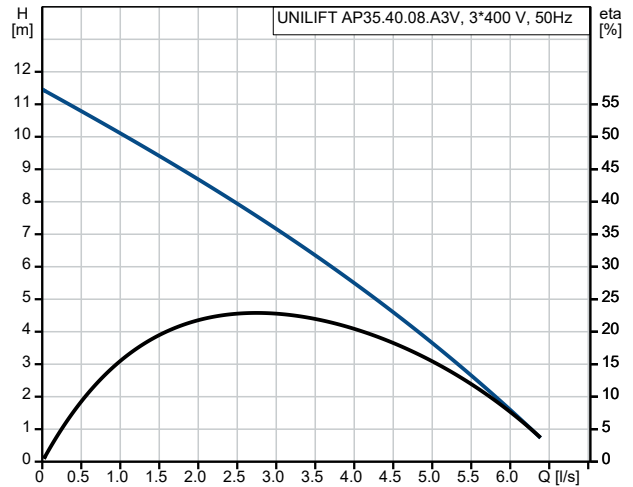

On request UNILIFT AP35.40.08.A3V 50 Hz

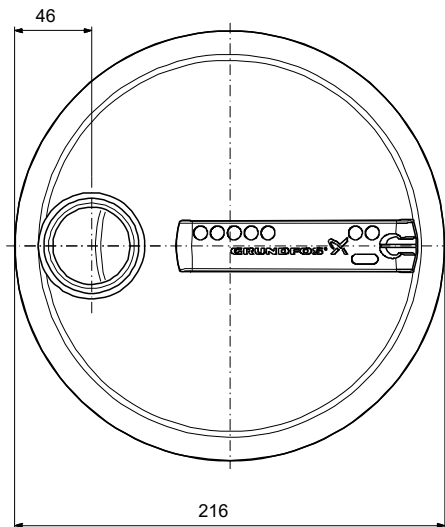
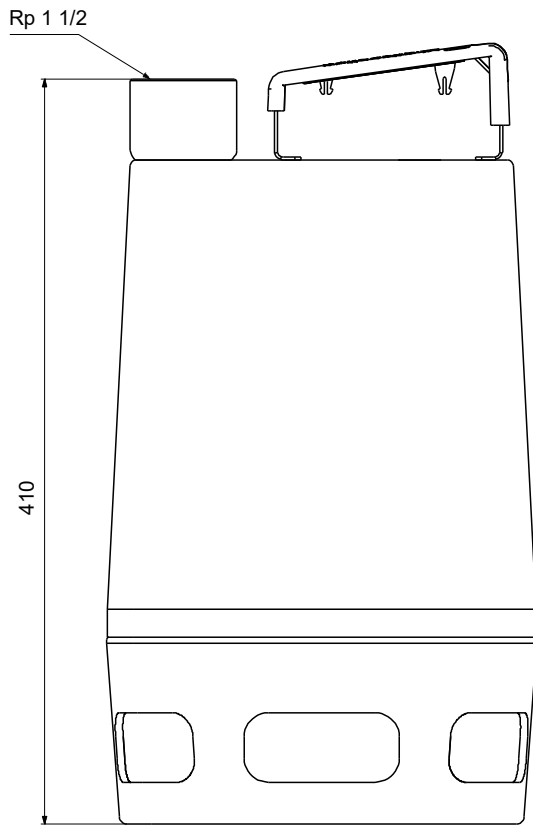

Note! All units are in [mm] unless others are stated.
Disclaimer: This simplified dimensional drawing does not show all details.

