

# Submittal Data

PROJECT:	UNIT TAG:	QUANTITY:
REPRESENTATIVE: _____	TYPE OF SERVICE:	DATE: _____
ENGINEER:	SUBMITTED BY:	DATE:
CONTRACTOR:	APPROVED BY:	DATE:
	ORDER NO.:	DATE:



## CR 32-9-2 A-F-A-V-HQQV

Vertical, multistage centrifugal pump with suction and discharge ports on the same level. The pump head and base are in cast iron - all other wetted parts are in stainless steel (EN 1.4301)

Note! Product picture may differ from actual product

Conditions of Service	Pump Data	Motor Data
	Max pressure at stated temp: 30 bar / 90 °C Liquid temperature range: -20 .. 90 °C Maximum ambient temperature: 60 °C Shaft seal: HQQV Product number: On request	Rated power - P2: 18.5 kW Rated voltage: 380-415D/660-690Y V Mains frequency: 50 Hz Enclosure class: 55 Dust/Jetting Insulation class: F Motor protection: PTC Motor type: 160LB Eta 1/1: 92.4-92.4 %

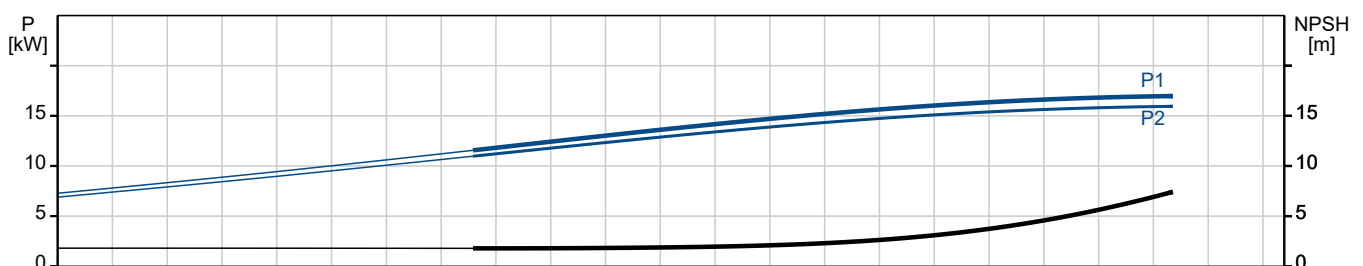
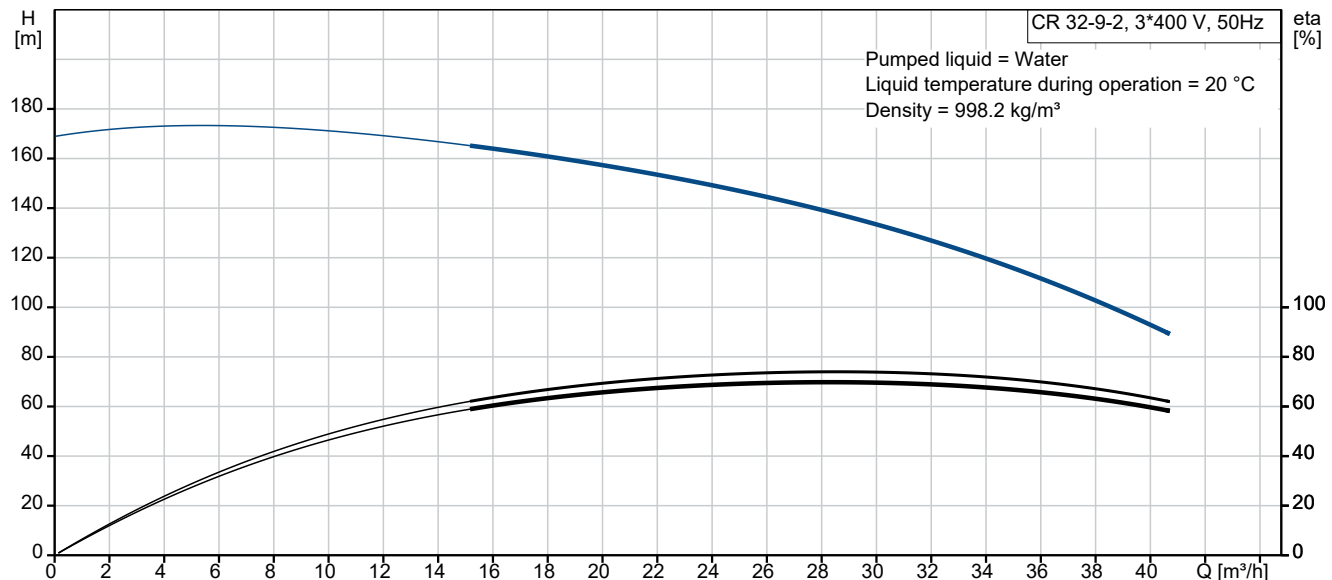

# Submittal Data

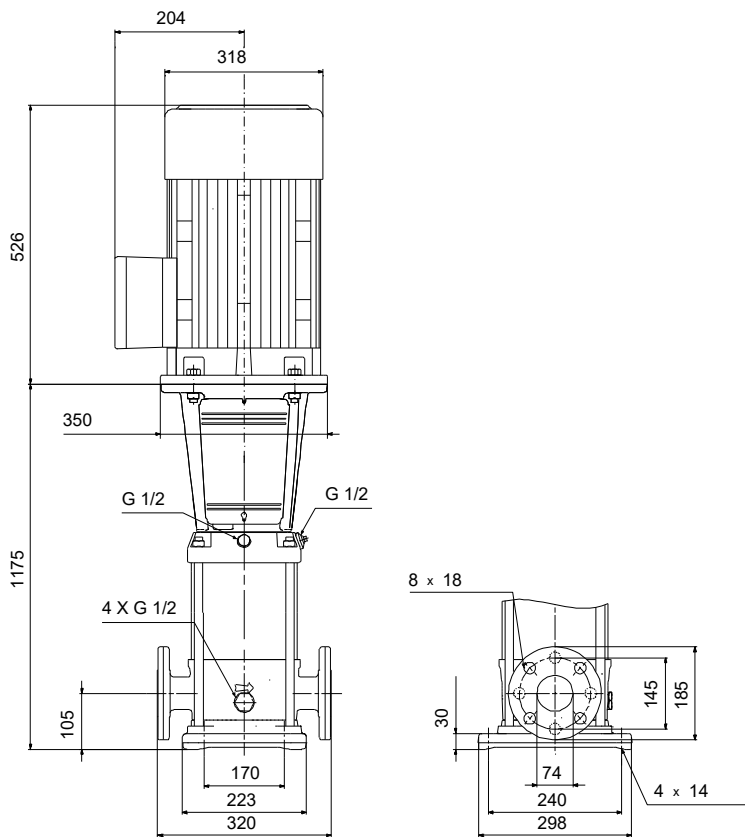

## Materials:

Base: Cast iron  
Base: EN 1563 EN-GJS-500-7  
Base: ASTM A536 80-55-06  
Impeller: Stainless steel  
Impeller: AISI 304  
Impeller: EN 1.4301  
Material code: A  
Code for rubber: V

Project:

Reference Number:

Client:

Client Number:

Contact:

Qty.	Description
1	<p><b>CR 32-9-2 A-F-A-V-HQQV</b></p>  <p style="text-align: center;"><b>Note! Product picture may differ from actual product</b></p> <p>Product No.: On request</p> <p>Vertical, multistage centrifugal pump with inlet and outlet ports on same the level (inline). The pump head and base are in cast iron – all other wetted parts are in stainless steel. A cartridge shaft seal ensures high reliability, safe handling, and easy access and service. Power transmission is via a rigid split coupling. Pipe connection is via DIN flanges.</p> <p>The pump is fitted with a 3-phase, fan-cooled asynchronous motor.</p> <p><b>Further product details</b></p> <p>Steel, cast iron and aluminium components have an epoxy-based coating made in a cathodic electro-deposition (CED) process.</p> <p>CED is a high-quality dip-painting process where an electrical field around the products ensures deposition of paint particles as a thin, well-controlled layer on the surface.</p> <p>An integral part of the process is a pretreatment.</p> <p>The entire process consists of these elements:</p> <ol style="list-style-type: none"> <li>1) Alkaline-based cleaning.</li> <li>2) Zinc phosphating.</li> <li>3) Cathodic electro-deposition.</li> <li>4) Curing to a dry film thickness 18-22 my m.</li> </ol> <p>The colour code for the finished product is NCS 9000/RAL 9005.</p> <p><b>Pump</b></p> <p>A long split coupling connects the pump and motor shaft. It is enclosed in the motor stool by means of two coupling guards. The long coupling makes it possible to replace the shaft seal without removing the motor from the pump.</p>  <p>The motor stool connects the pump head and motor. The pump head has a combined 1/2" priming plug and vent screw.</p>

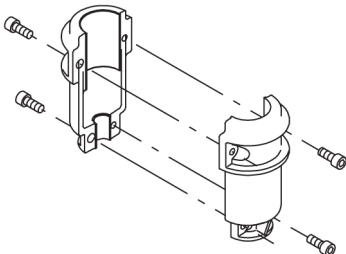

Qty.	Description
1	<div data-bbox="209 461 687 707">  </div> <p data-bbox="204 741 1460 882">The pump is fitted with a balanced O-ring seal unit with a rigid torque-transmission system. This seal type is assembled in a cartridge unit which makes replacement safe and easy. Due to the balancing, this seal type is suitable for high-pressure applications. The cartridge construction also protects the pump shaft from possible wear from a dynamic O-ring between pump shaft and shaft seal.</p> <p data-bbox="204 891 320 920">Seal faces:</p> <ul data-bbox="240 920 788 981" style="list-style-type: none"> <li>• Rotating seal ring material: silicon carbide (SiC)</li> <li>• Stationary seat material: silicon carbide (SiC)</li> </ul> <p data-bbox="204 981 1460 1032">This material pairing is used where higher corrosion resistance is required. The high hardness of this material pairing offers good resistance against abrasive particles.</p> <p data-bbox="204 1039 759 1068">Secondary seal material: FKM (fluorocarbon rubber)</p> <p data-bbox="204 1068 1437 1097">FKM has excellent resistance to oils and chemicals. Above 90 °C, FKM should only be used in media without water.</p> <div data-bbox="204 1133 612 1312">  </div> <p data-bbox="204 1346 1422 1375">The shaft seal is retained in the pump head by a cover and screws. It can be replaced without removing the motor.</p> <p data-bbox="204 1404 1422 1480">The chambers and impellers are made of stainless-steel sheet. The chambers are provided with a PTFE neck ring offering improved sealing and high efficiency. The impellers have smooth surfaces, and the shape of the blades ensure a high efficiency.</p> <p data-bbox="204 1518 1437 1594">The base is made of cast iron. Both the inlet and the outlet side of the base have two pressure gauge tappings. The pump is secured to the foundation by four bolts through the base plate. The flanges are fastened to the base by means of locking rings.</p> <div data-bbox="204 1608 395 1794">  </div> <p data-bbox="204 1852 284 1883"><b>Motor</b></p> <p data-bbox="204 1890 1430 1942">The motor is a totally enclosed, fan-cooled motor with principal dimensions to IEC and DIN standards. The motor is flange-mounted with free-hole flange (FF).</p> <p data-bbox="204 1946 1241 1975">Motor-mounting designation in accordance with IEC 60034-7: IM B 5 (Code I) / IM 3001 (Code II).</p> <p data-bbox="204 1977 679 2007">Electrical tolerances comply with IEC 60034.</p> <p data-bbox="204 2009 1015 2038">The motor efficiency is classified as IE3 in accordance with IEC 60034-30-1.</p> <p data-bbox="204 2040 1430 2092">The motor has thermistors (PTC sensors) in the windings in accordance with DIN 44081/DIN 44082. The protection reacts to both slow- and quick-rising temperatures, e.g. constant overload and stalled conditions.</p>

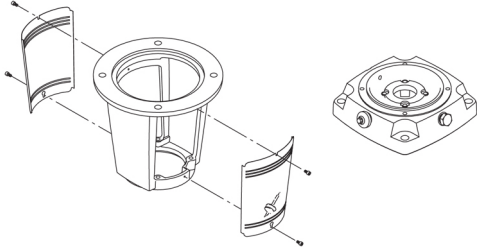
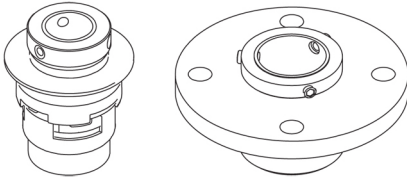
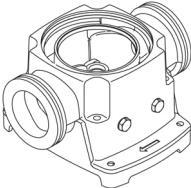
**Project:**  
**Reference Number:**
**Client:**  
**Client Number:**  
**Contact:**

Qty.	Description
1	<p>Thermal switches must be connected to an external control circuit in a way which ensures that the automatic reset cannot cause accidents. The motors must be connected to a motor-protective circuit breaker according to local regulations.</p> <p>The motor can be connected to a variable speed drive for adjustment of pump performance to any duty point. Grundfos CUE offers a range of variable speed drives. Please find more information in Grundfos Product Center.</p> <p><b>Technical data</b></p> <p>Liquid:  Liquid temperature range: -20 .. 90 °C</p> <p>Technical:  Pump speed on which pump data are based: 2934 rpm  Rated flow: 30 m³/h  Rated head: 131.6 m  Pump orientation: Vertical  Shaft seal arrangement: Single  Code for shaft seal: HQQV  Approvals: CE,EAC,UKCA,SEPRO  Approvals for drinking water: WRAS  Curve tolerance: ISO9906:2012 3B</p> <p>Materials:  Base: Cast iron  EN 1563 EN-GJS-500-7  ASTM A536 80-55-06</p> <p>Impeller: Stainless steel  EN 1.4301  AISI 304</p> <p>Bearing: SIC  Support bearing: Graflon</p> <p>Installation:  Maximum ambient temperature: 60 °C  Maximum operating pressure: 30 bar  Max pressure at stated temp: 30 bar / 90 °C  30 bar / -20 °C</p> <p>Type of connection: DIN  Size of inlet connection: DN 65  Size of outlet connection: DN 65  Pressure rating for connection: PN 40  Flange size for motor: FF300</p> <p>Electrical data:  Motor standard: IEC  Motor type: 160LB  Rated power - P2: 18.5 kW  Power (P2) required by pump: 18.5 kW  Mains frequency: 50 Hz  Rated voltage: 3 x 380-415D/660-690Y V  Rated current: 34,5-32,5/20,0-18,8 A  Starting current: 830-980 %  Cos phi - power factor: 0.89-0.85  Rated speed: 2940-2950 rpm</p>



Company name:

Created by:

Phone:

Date: 19/12/2023

Project:

Reference Number:

Client:

Client Number:

Contact:

Qty.	Description
1	IE Efficiency class: IE3 Motor efficiency at full load: 92.4-92.4 % Motor efficiency at 3/4 load: 93.2-93.0 % Motor efficiency at 1/2 load: 93.2-92.2 % Number of poles: 2 Enclosure class (IEC 34-5): 55 Dust/Jetting Insulation class (IEC 85): F Motor No: 85U17528  Controls: Frequency converter: None  Others: Terminal box position: 6 Minimum efficiency index, MEI ≥: 0.70 Net weight: 198 kg Gross weight: 237 kg Shipping volume: 0.805 m <sup>3</sup> Country of origin: DK Custom tariff no.: 84137075



Company name:  
Created by:  
Phone:

Date: 19/12/2023

Project:  
Reference Number:

Client:  
Client Number:  
Contact:

## On request CR 32-9-2 A-F-A-V-HQQV 50 Hz

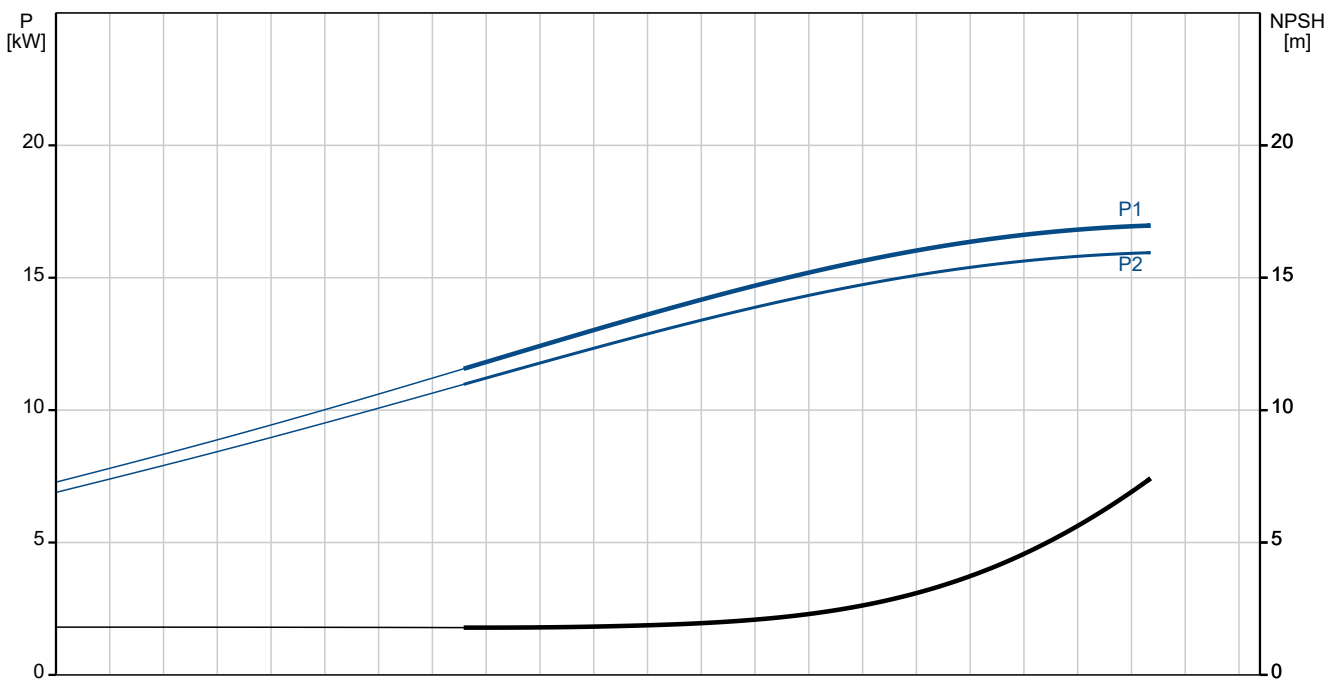
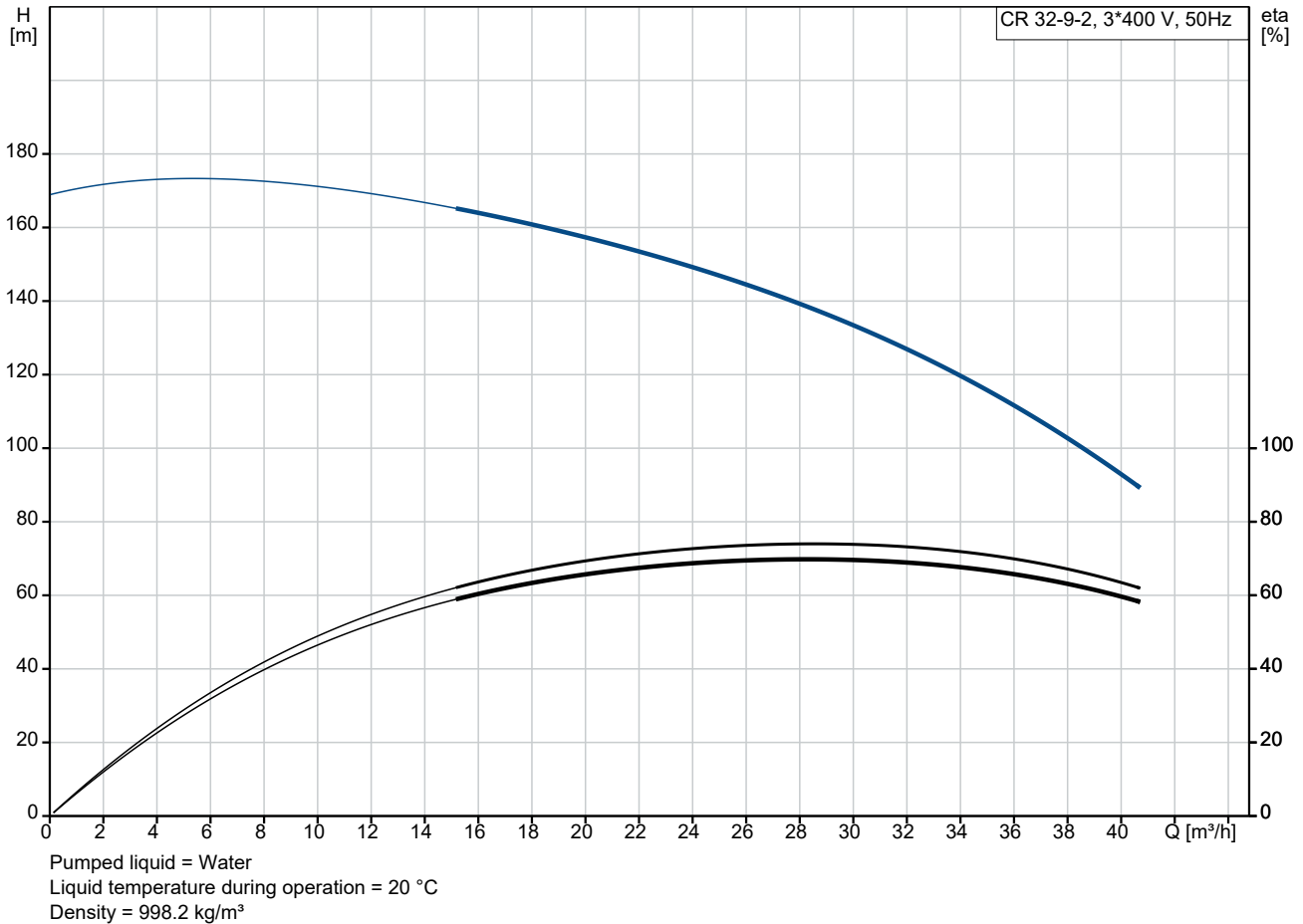

**Project:**

Reference Number:

**Client:**

Client Number:

Contact:

Description	Value
<b>General information:</b>	
Product name:	CR 32-9-2 A-F-A-V-HQQV
Product No:	On request
EAN number:	On request
<b>Technical:</b>	
Pump speed on which pump data are based:	2934 rpm
Rated flow:	30 m <sup>3</sup> /h
Rated head:	131.6 m
Maximum head:	168 m
Stages:	9
Impellers:	9
Number of reduced-diameter impellers:	2
Low NPSH:	N
Pump orientation:	Vertical
Shaft seal arrangement:	Single
Code for shaft seal:	HQQV
Approvals:	CE,EAC,UKCA,SEPRO
Approvals for drinking water:	WRAS
Curve tolerance:	ISO9906:2012 3B
Pump version:	A
Model:	B
<b>Materials:</b>	
Base:	Cast iron
Base:	EN 1563 EN-GJS-500-7
Base:	ASTM A536 80-55-06
Impeller:	Stainless steel
Impeller:	EN 1.4301
Impeller:	AISI 304
Material code:	A
Code for rubber:	V
Bearing:	SIC
Support bearing:	Graflon
<b>Installation:</b>	
Maximum ambient temperature:	60 °C
Maximum operating pressure:	30 bar
Max pressure at stated temp:	30 bar / 90 °C
Max pressure at stated temp:	30 bar / -20 °C
Type of connection:	DIN
Size of inlet connection:	DN 65
Size of outlet connection:	DN 65
Pressure rating for connection:	PN 40
Flange size for motor:	FF300
Connect code:	F
<b>Liquid:</b>	
Liquid temperature range:	-20 .. 90 °C
<b>Electrical data:</b>	
Motor standard:	IEC
Motor type:	160LB
Rated power - P1:	18.5 kW
Power (P2) required by pump:	18.5 kW
Mains frequency:	50 Hz

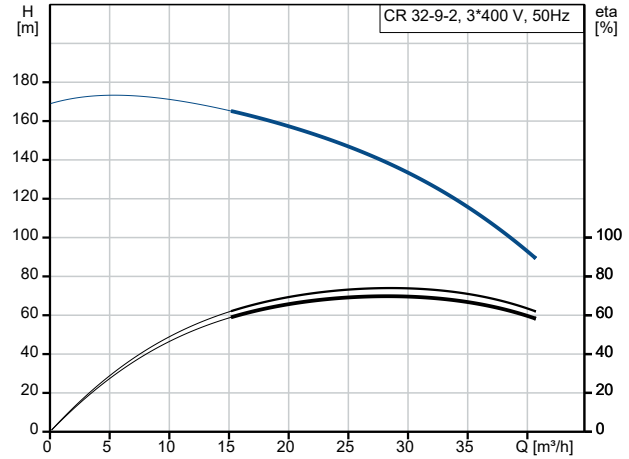

Pumped liquid = Water  
Liquid temperature during operation = 20 °C  
Density = 998.2 kg/m<sup>3</sup>

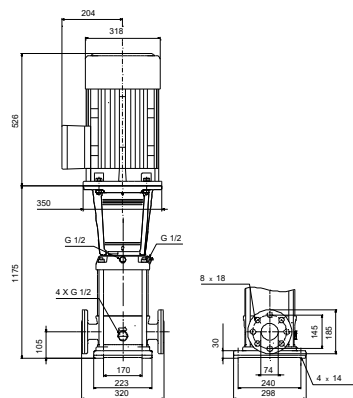
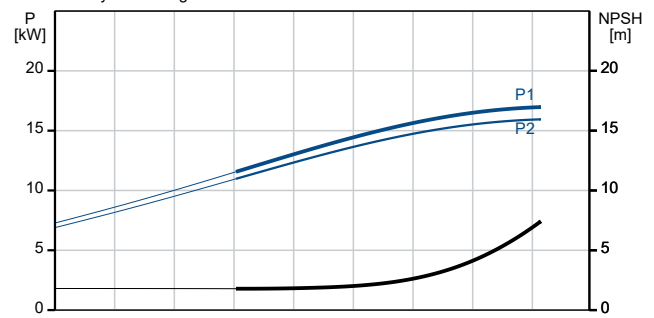



Company name:

Created by:

Phone:

Date: 19/12/2023

Project:

Reference Number:

Client:

Client Number:

Contact:

Description	Value
Rated voltage:	3 x 380-415D/660-690Y V
Rated current:	34,5-32,5/20,0-18,8 A
Starting current:	830-980 %
Cos phi - power factor:	0.89-0.85
Rated speed:	2940-2950 rpm
IE Efficiency class:	IE3
Motor efficiency at full load:	92.4-92.4 %
Motor efficiency at 3/4 load:	93.2-93.0 %
Motor efficiency at 1/2 load:	93.2-92.2 %
Number of poles:	2
Enclosure class (IEC 34-5):	55 Dust/Jetting
Insulation class (IEC 85):	F
Built-in motor protection:	PTC
Motor No:	85U17528
<b>Controls:</b>	
Frequency converter:	None
<b>Others:</b>	
Terminal box position:	6
Minimum efficiency index, MEI $\geq$ :	0.70
Net weight:	198 kg
Gross weight:	237 kg
Shipping volume:	0.805 m <sup>3</sup>
Country of origin:	DK
Custom tariff no.:	84137075



Company name:  
Created by:  
Phone:

Date: 19/12/2023

Project:  
Reference Number:

Client:  
Client Number:  
Contact:

### On request CR 32-9-2 A-F-A-V-HQQV 50 Hz

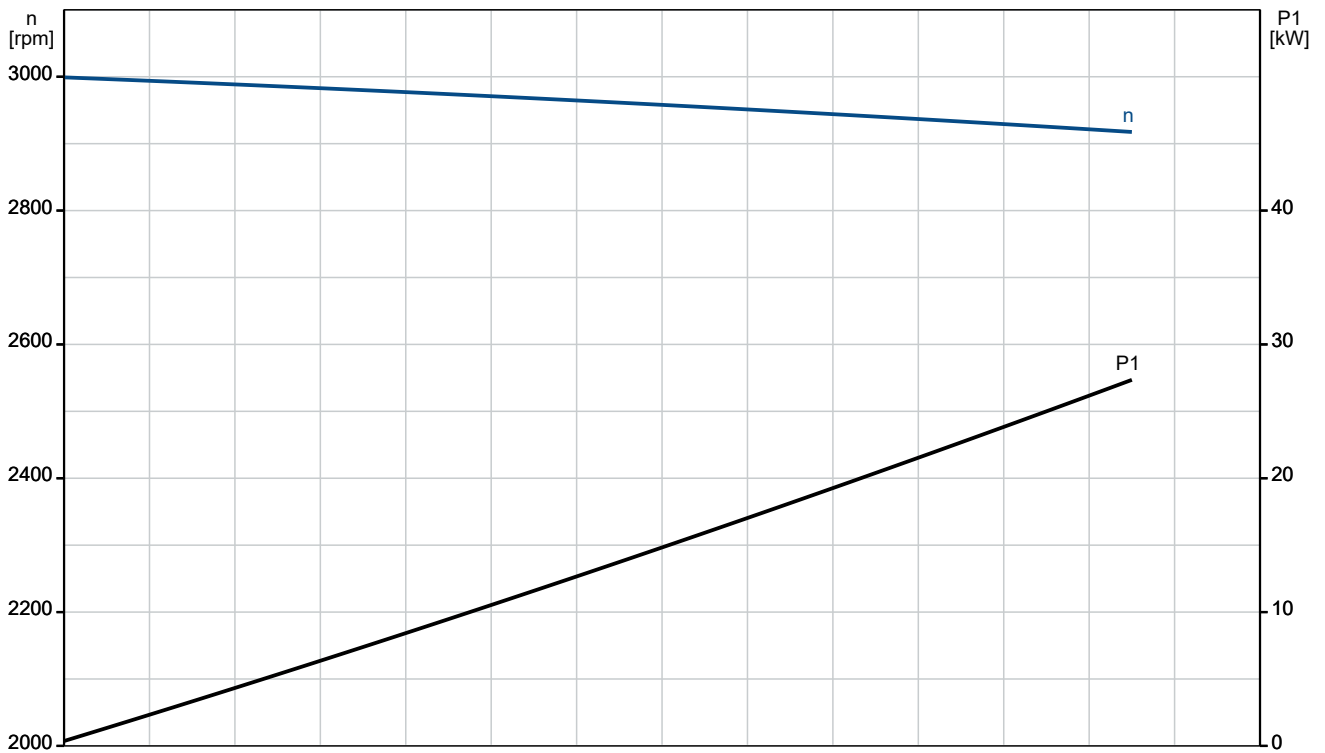
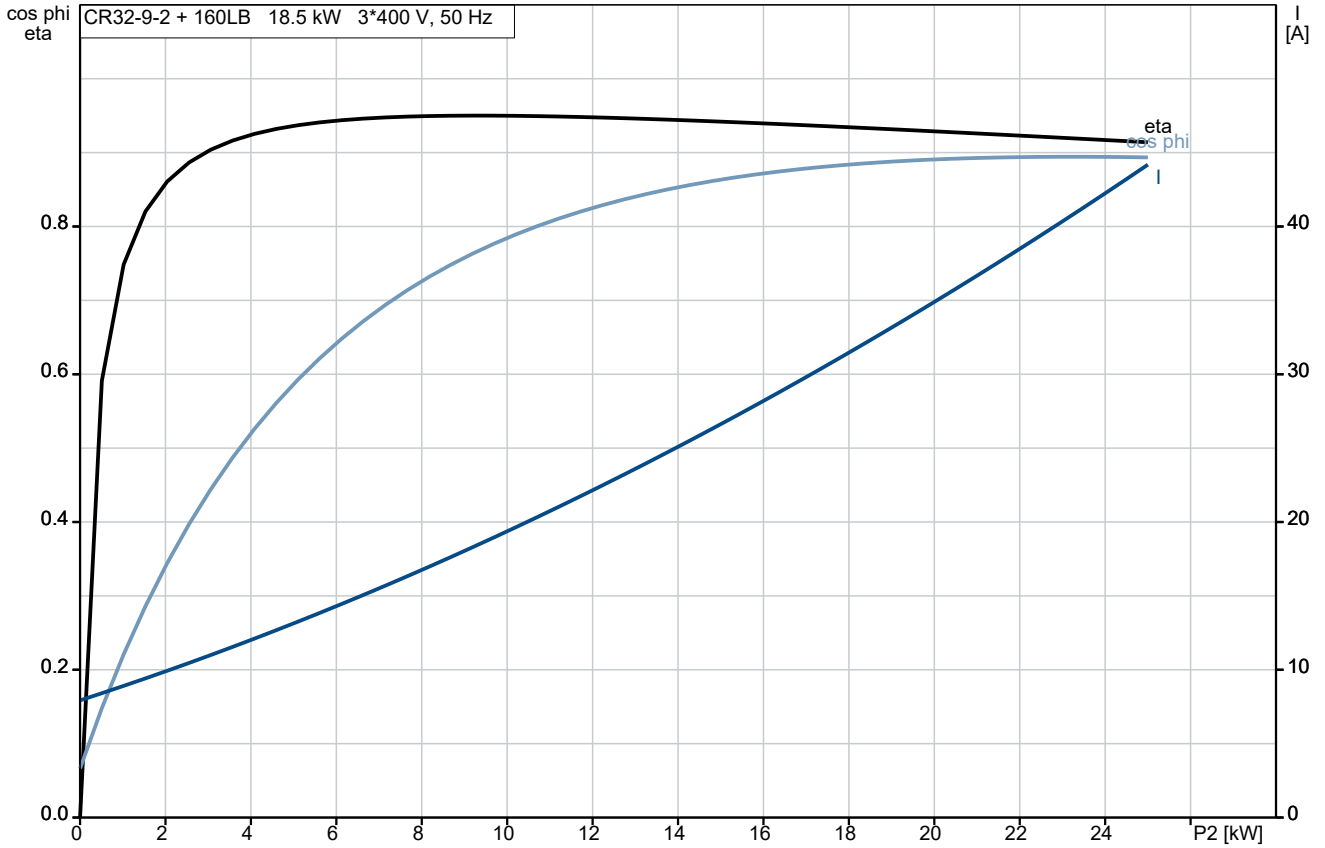



## On request CR 32-9-2 A-F-A-V-HQQV 50 Hz



IEC TP211 THERMALLY PROTECTED WHEN THE THERMISTORS ARE CONNECTED TO AMPLIFIER RELAY FOR CONTROL OF MAIN SUPPLY THERMISTORS PTC ACCORDING TO DIN 44082

Note! All units are in [mm] unless others are stated.

