

Submittal Data

PROJECT:	UNIT TAG:	QUANTITY:
REPRESENTATIVE: _____	TYPE OF SERVICE:	DATE: _____
ENGINEER:	SUBMITTED BY:	DATE:
CONTRACTOR:	APPROVED BY:	DATE:
	ORDER NO.:	DATE:



MAGNA3 80-40 F

The MAGNA3 is the premium choice when system control and monitoring is key. MAGNA3 supports fieldbus by optional CIM modules, and connects directly with the Grundfos GO app via Bluetooth.

Note! Product picture may differ from actual product

Conditions of Service		Pump Data		Motor Data	
Liquid:	Water	Liquid temperature range:	-10 .. 110 °C	Mains frequency:	50 / 60 Hz
Temperature:	60 °C	Maximum ambient temperature:	40 °C	Enclosure class:	X4D
Specific Gravity:	0.985	Product number:	On request		

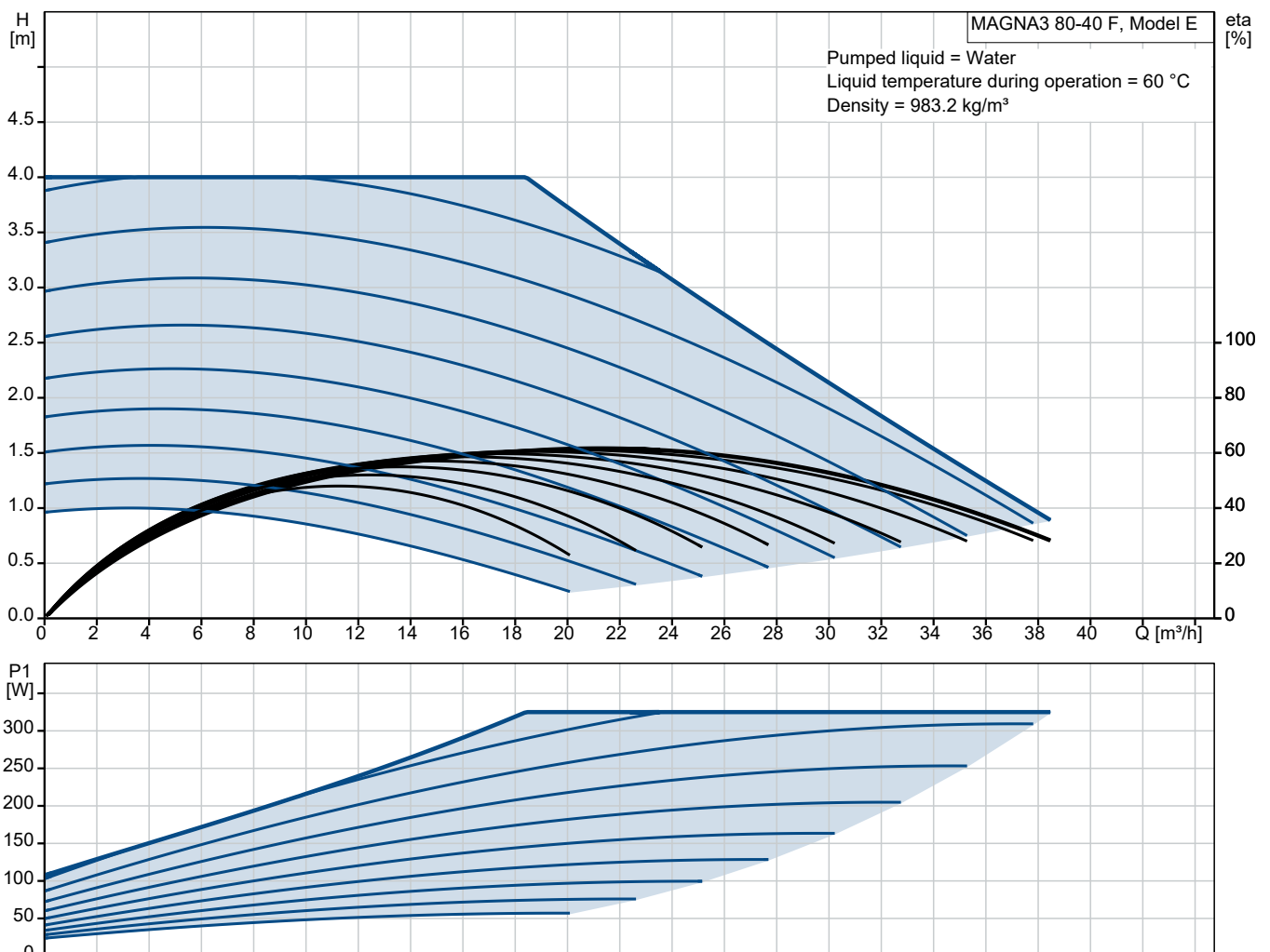

Submittal Data

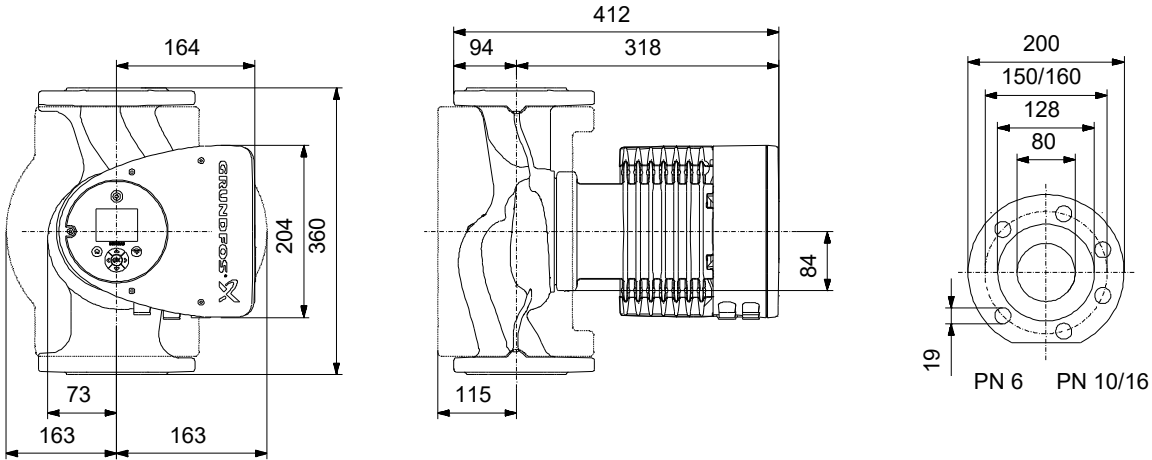

Materials:
 Pump housing: Cast iron
 Pump housing: ASTM A48-250B
 Impeller: Composite

Qty.	Description
------	-------------

1	MAGNA3 80-40 F
---	----------------



Note! Product picture may differ from actual product

Product No.: On request

The Grundfos MAGNA3 circulator pump is the ideal choice for almost any building project – old or new. With its unrivalled energy efficiency, all-encompassing range and built-in communication capabilities, MAGNA3 is ideal for engineers and specifiers looking to create high-performance heating and cooling systems.

The pump is maintenance-free due to the canned-rotor type design. This also means that pump and motor form an integral unit without shaft seal and with only two gaskets for sealing. The bearings are lubricated by the pumped liquid.

MAGNA3 features an intuitive display and allows you to connect wirelessly with the Grundfos GO Remote app, giving you access to advanced reporting and monitoring.

MAGNA3 model E has Bluetooth, which allows you to connect directly to Grundfos Go app on your smart phone without any need for a dongle.

The pump includes fieldbus communication via CIM modules as well as analog and digital inputs and configurable relays.

Control features include AUTOADAPT and FLOWADAPT. FLOWADAPT which reduces the need for throttling valves, thus cutting costs on system components.

MAGNA3 is the superior choice for a wide range of heating and cooling applications, including:

- Mixing loops
- Heating surfaces
- Air conditioning surfaces
- Ground-source heat pump systems
- Smaller chiller applications.

MAGNA3 is a single-phase pump and characterised by having the controller and control display integrated in the control box. The pump also has a built-in differential-pressure and temperature sensor.

The pump housing is available in both cast-iron and stainless-steel versions. The composite rotor can is carbon-fibre reinforced, the bearing plate and rotor cladding are made of stainless steel and the stator housing is made of aluminium. The power electronics are air-cooled.

MAGNA3 incorporates a 4-pole synchronous, permanent-magnet motor (PM motor). This motor type is characterised by higher efficiency than a conventional asynchronous squirrel-cage motor. The pump speed is controlled by an integrated frequency converter.



Company name:
Created by:
Phone:

Date: 29/11/2023

Project:
Reference Number:

Client:
Client Number:
Contact:

On request MAGNA3 80-40 F

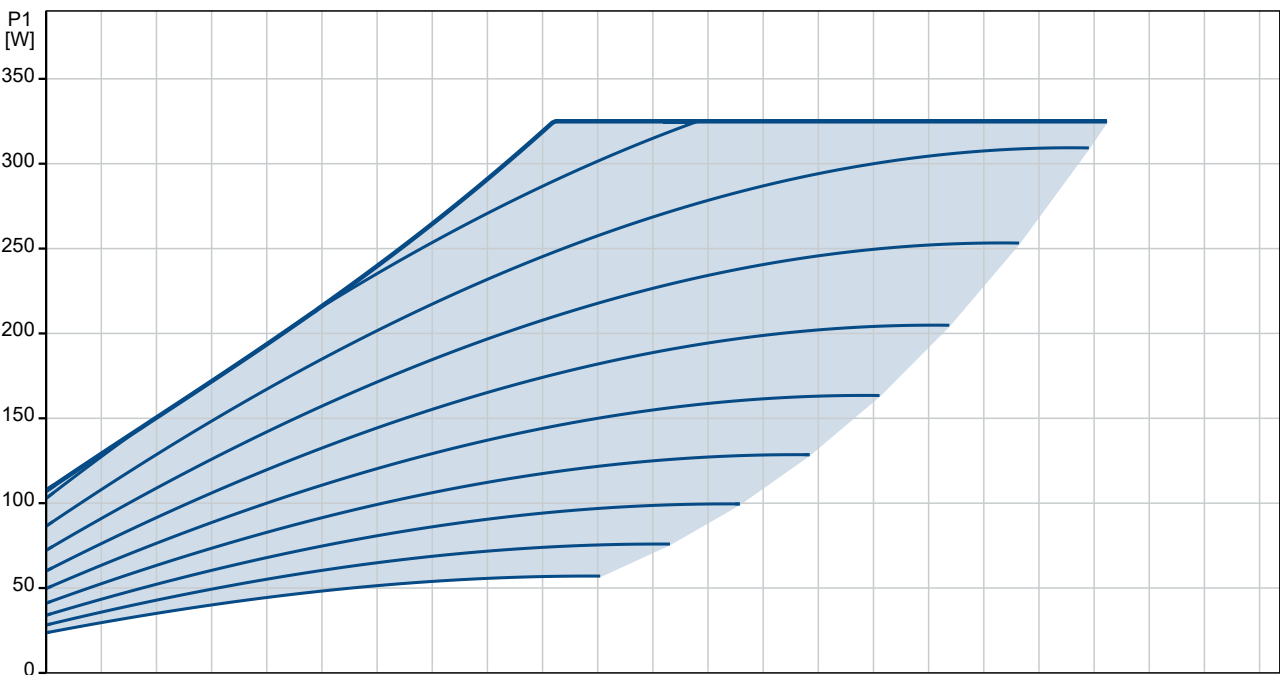
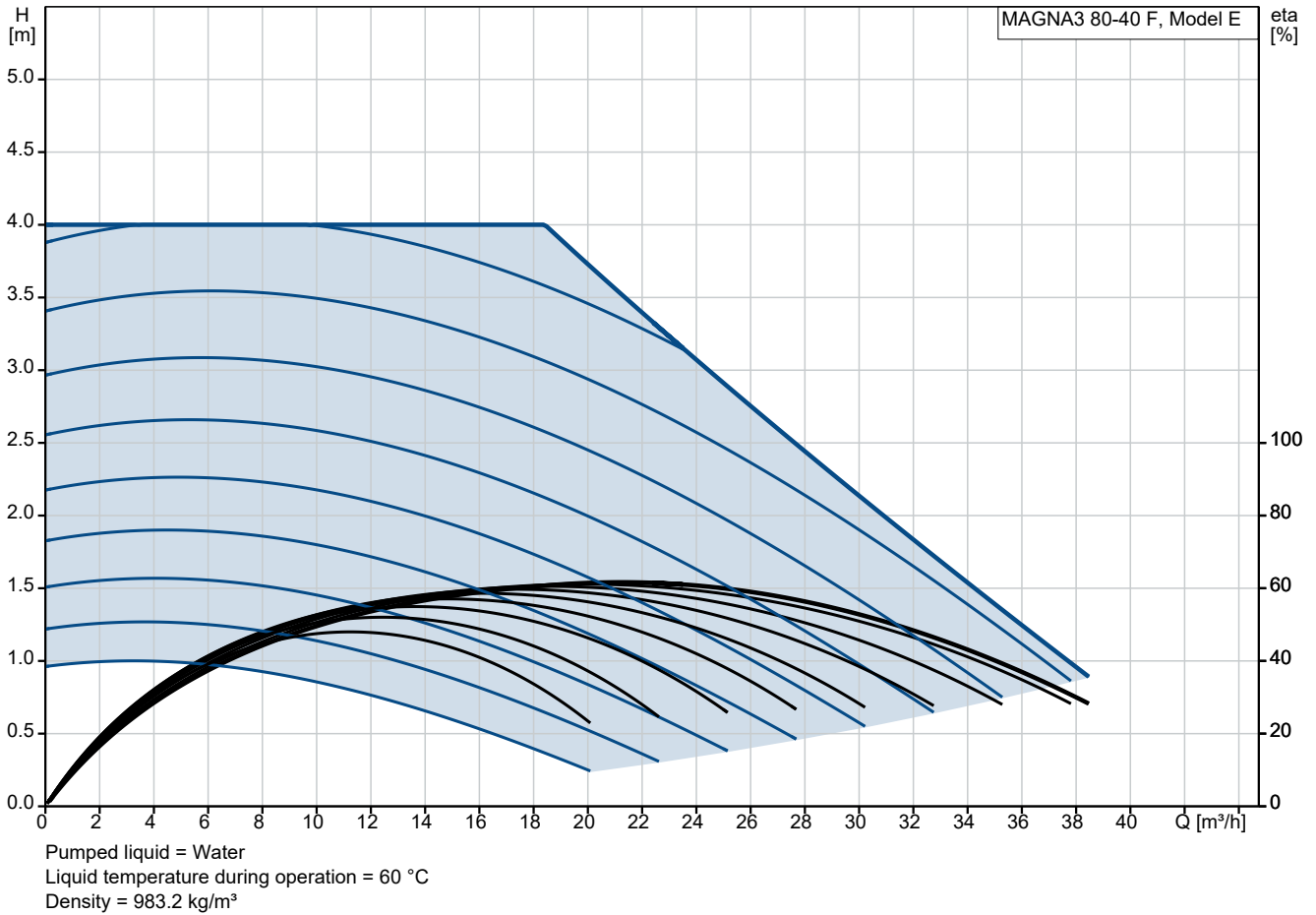

Project:

Reference Number:

Client:

Client Number:

Contact:

Description	Value
General information:	
Product name:	MAGNA3 80-40 F
Product No:	On request
EAN number:	On request
Technical:	
Rated flow:	20.67 m ³ /h
Rated head:	3.617 m
Maximum head:	40 dm
TF class:	110
Approvals:	CE, VDE
Model:	E
Materials:	
Pump housing:	Cast iron
Pump housing:	EN 1561 EN-GJL-250
Pump housing:	ASTM A48-250B
Impeller:	Composite
Installation:	
Range of ambient temperature:	0 .. 40 °C
Maximum operating pressure:	16 bar
Type of connection:	DIN
Size of connection:	DN 80
Pressure rating for connection:	PN 16
Port-to-port length:	360 mm
Liquid:	
Pumped liquid:	Water
Liquid temperature range:	-10 .. 110 °C
Selected liquid temperature:	60 °C
Density:	983.2 kg/m ³
Electrical data:	
Maximum power input - P1:	325 W
P1 min.:	24 W
Mains frequency:	50 / 60 Hz
Rated voltage:	1 x 230 V
Minimum current consumption:	0.26 A
Maximum current consumption:	1.52 A
Enclosure class (IEC 34-5):	X4D
Insulation class (IEC 85):	F
Others:	
Energy (EEI):	0.17
Net weight:	26.6 kg
Gross weight:	29.4 kg
Shipping volume:	0.071 m ³
Sales region:	D
Country of origin:	DE
Custom tariff no.:	84137030
Environmental approvals:	WEEE

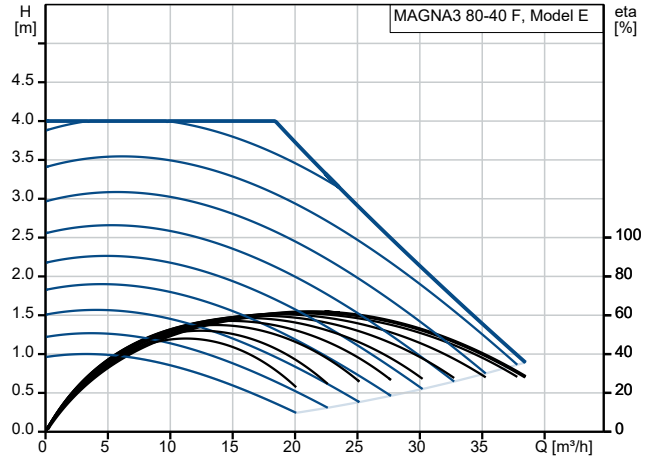

Pumped liquid = Water
 Liquid temperature during operation = 60 °C
 Density = 983.2 kg/m³

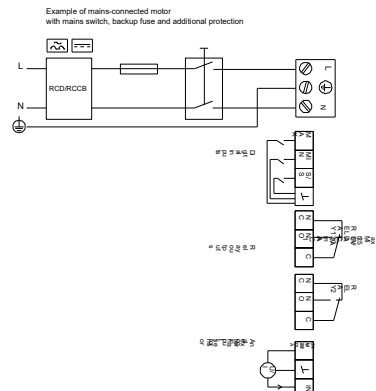
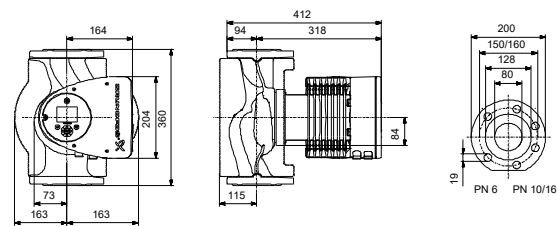
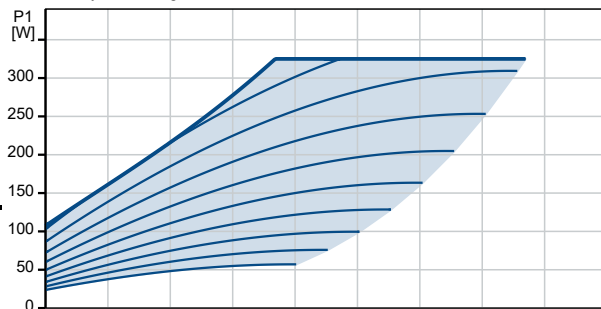

On request MAGNA3 80-40 F

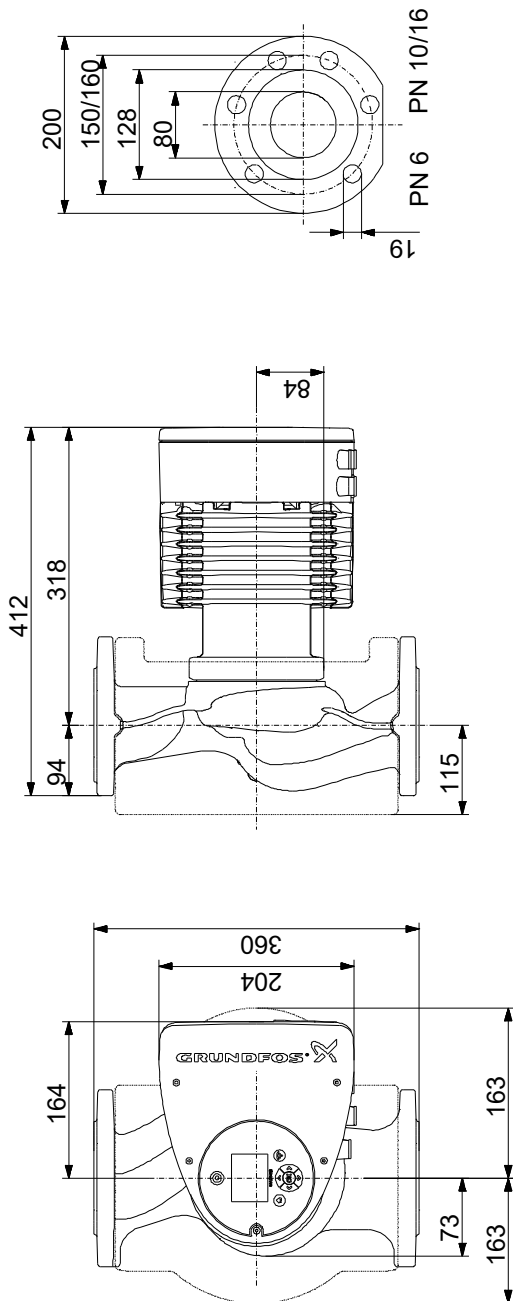

Note! All units are in [mm] unless others are stated.
Disclaimer: This simplified dimensional drawing does not show all details.

On request MAGNA3 80-40 F

Example of mains-connected motor with mains switch, backup fuse and additional protection



Note! All units are in [mm] unless others are stated.

