

Qty. Description

1 TP 40-60/2 A-F-A-BQQE-CW1



Note! Product picture may differ from actual product

Product No.: On request

Single-stage, close-coupled, volute pump with in-line suction and discharge ports of identical diameter. The pump is of the top-pull-out design, i.e. the power head (motor, pump head and impeller) can be removed for maintenance or service while the pump housing remains in the pipework.

The pump is fitted with an unbalanced rubber bellows seal. The shaft seal is according to EN 12756. Pipework connection is via PN 6/10 DIN flanges (EN 1092-2 and ISO 7005-2).

The pump is fitted with a fan-cooled asynchronous motor.

Cast-iron parts have an epoxy-based coating made in a cathodic electro-deposition (CED) process. CED is a high-quality dip-painting process where an electrical field around the products ensures deposition of paint particles as a thin, well-controlled layer on the surface.

Pump

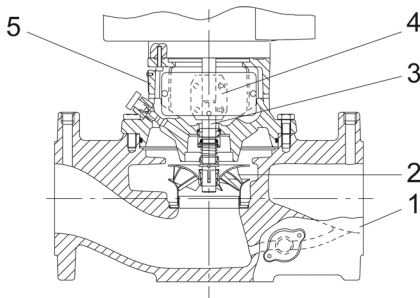

1: Pump housing

2: Impeller

3: Shaft

4: Coupling

5: Pump head

The pump housing is provided with a replaceable stainless steel/PTFE neck ring to reduce the amount of liquid running from the discharge side of the impeller to the suction side.

The impeller is secured with a split cone with nut.

The pump is fitted with an unbalanced rubber bellows seal with torque transmission across the spring and around the bellows. Due to the bellows, the seal does not wear the shaft, and the axial movement is not prevented by deposits on the shaft.

Seal faces:

- Rotating seal ring material: silicon carbide (SiC)
- Stationary seat material: silicon carbide (SiC)

This material pairing is used where higher corrosion resistance is required. The high hardness of this material pairing offers good resistance against abrasive particles.

Secondary seal material: EPDM (ethylene-propylene rubber)

EPDM has excellent resistance to hot water. EPDM is not suitable for mineral oils.

A circulation of liquid through the duct of the air vent screw ensures lubrication and cooling of the shaft seal.

The flanges have tappings for mounting of pressure gauges.

The motor stool forms connection between the pump housing and the motor, and is equipped with a manual air vent screw for venting of the pump housing and the shaft seal chamber. The sealing between motor stool and pump housing is an O-ring.

Qty.	Description
1	<p>The central part of the motor stool is provided with guards for protection against the shaft and coupling. Motor and pump shaft are connected via a shell coupling.</p> <p>Motor</p> <p>The motor is a totally enclosed, fan-cooled motor with principal dimensions to IEC and DIN standards. Electrical tolerances comply with IEC 60034.</p> <p>The motor is flange-mounted with tapped-hole flange (FT). Motor-mounting designation in accordance with IEC 60034-7: IM B 14, IM V 18 (Code I) / IM 3601, IM 3611 (Code II).</p> <p>The motor efficiency is classified as IE3 in accordance with IEC 60034-30-1.</p> <p>The motor does not incorporate motor protection and must be connected to a motor-protective circuit breaker which can be manually reset. The motor-protective circuit breaker must be set according to the rated current of the motor (I1/1).</p> <p>Further product details</p> <p>Cast-iron parts have an epoxy-based coating made in a cathodic electro-deposition (CED) process. CED is a high-quality dip-painting process where an electrical field around the products ensures deposition of paint particles as a thin, well-controlled layer on the surface.</p> <p>Technical data</p> <p>Controls:</p> <p>Frequency converter: None</p> <p>Liquid:</p> <p>Liquid temperature range: -25 .. 120 °C</p> <p>Technical:</p> <p>Pump speed on which pump data are based: 2770 rpm</p> <p>Rated flow: 10.4 m³/h</p> <p>Rated head: 4.6 m</p> <p>Actual impeller diameter: 70 mm</p> <p>Code for shaft seal: BQQE</p> <p>Curve tolerance: ISO9906:2012 3B2</p> <p>Materials:</p> <p>Pump housing: Cast iron EN-GJL-250 ASTM class 35</p> <p>Impeller: Stainless steel EN 1.4301 AISI 304</p> <p>Installation:</p> <p>Range of ambient temperature: -30 .. 60 °C</p> <p>Maximum operating pressure: 10 bar</p> <p>Max pressure at stated temp: 10 bar / 120 °C</p> <p>Type of connection: DIN</p> <p>Size of connection: DN 40</p> <p>Pressure rating for connection: PN 6/10</p> <p>Port-to-port length: 250 mm</p> <p>Flange size for motor: FT85</p> <p>Electrical data:</p> <p>Motor type: 71A</p> <p>Rated power - P2: 0.25 kW</p> <p>Mains frequency: 50 Hz</p>

Qty.	Description
------	-------------

1	Rated voltage: 3 x 220-255D/380-440Y V
	Rated current: 1.12/0.65 A
	Starting current: 570-620 %
	Cos phi - power factor: 0.83-0.71
	Rated speed: 2840-2880 rpm
	IE Efficiency class: IE3
	Motor efficiency at full load: 77.5-77.2 %
	Motor efficiency at 3/4 load: 76.8-74.5 %
	Motor efficiency at 1/2 load: 72.7-68.4 %
	Number of poles: 2
	Enclosure class (IEC 34-5): 55 Dust/Jetting
	Insulation class (IEC 85): F
	Motor No: 85105501
	Others:
	Minimum efficiency index, MEI \geq : 0.60
	Net weight: 19.9 kg
	Gross weight: 23.4 kg
	Shipping volume: 0.08 m ³
	Finnish LVI No.: 4616025
	Norwegian NRF no.: 9043539
	Country of origin: HU
	Custom tariff no.: 84137051

On request TP 40-60/2 A-F-A-BQQE-CW1 50 Hz

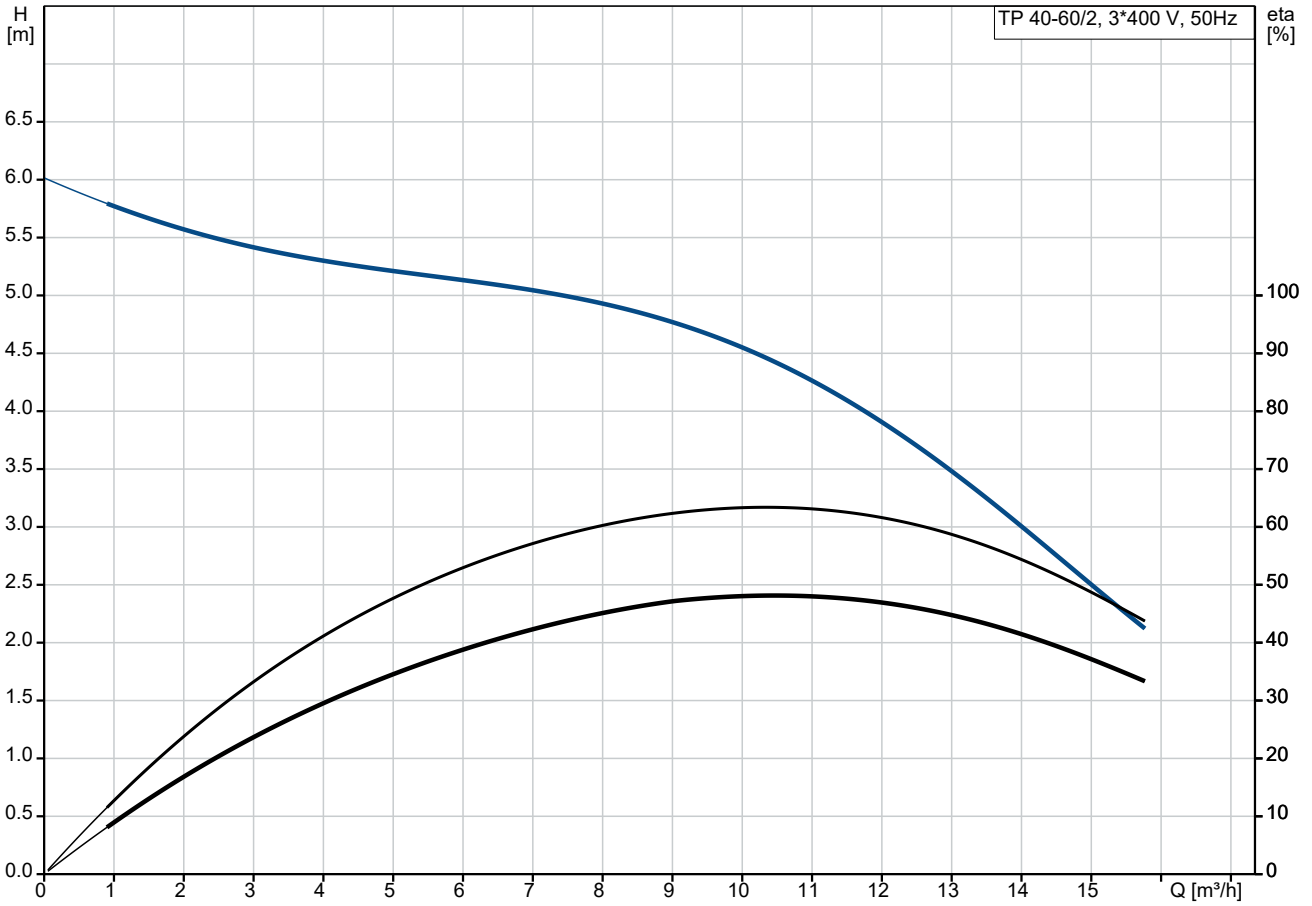

Pumped liquid = Water
 Liquid temperature during operation = 20 °C
 Density = 998.2 kg/m³

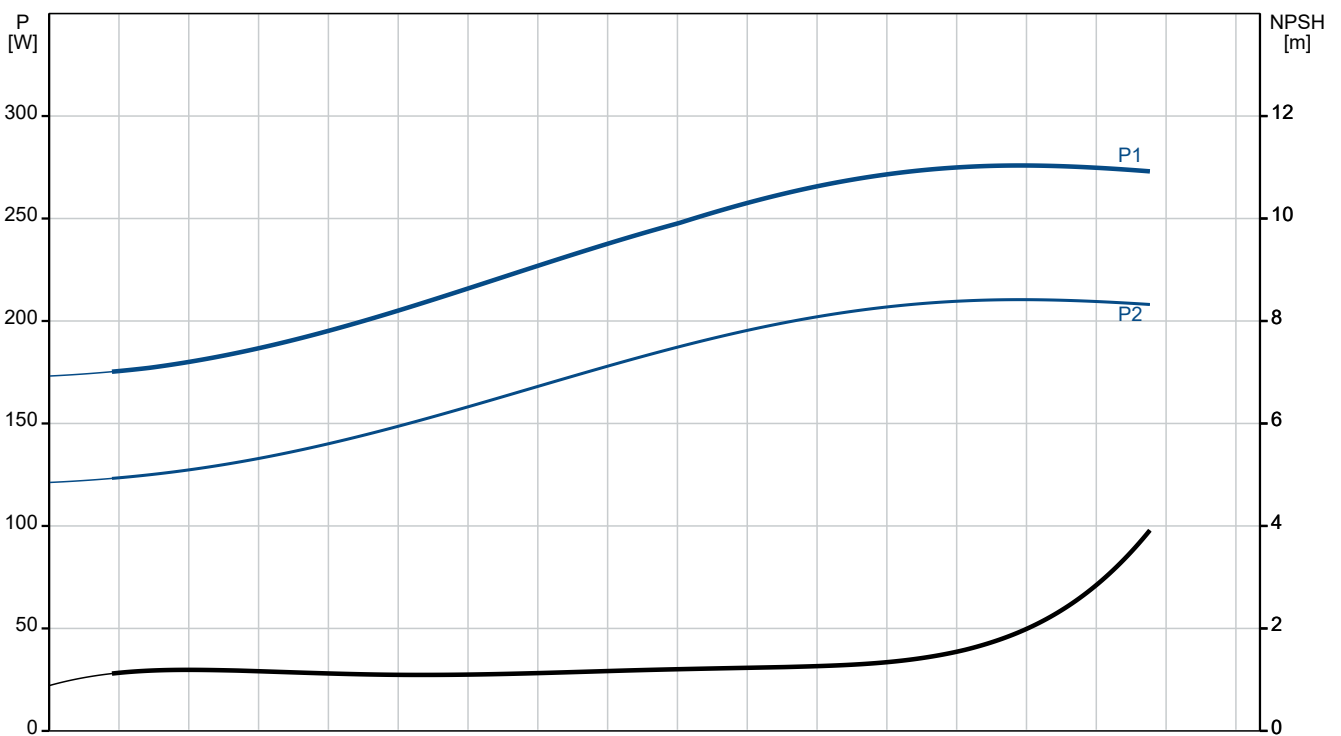

Description	Value
General information:	
Product name:	TP 40-60/2 A-F-A-BQQE-CW1
Product No:	On request
EAN number:	On request
Technical:	
Pump speed on which pump data are based:	2770 rpm
Rated flow:	10.4 m ³ /h
Rated head:	4.6 m
Maximum head:	60 dm
Actual impeller diameter:	70 mm
Code for shaft seal:	BQQE
Curve tolerance:	ISO9906:2012 3B2
Pump version:	A
Materials:	
Pump housing:	Cast iron
Pump housing:	EN-GJL-250
Pump housing:	ASTM class 35
Impeller:	Stainless steel
Impeller:	EN 1.4301
Impeller:	AISI 304
Material code:	A
Installation:	
Range of ambient temperature:	-30 .. 60 °C
Maximum operating pressure:	10 bar
Max pressure at stated temp:	10 bar / 120 °C
Type of connection:	DIN
Size of connection:	DN 40
Pressure rating for connection:	PN 6/10
Port-to-port length:	250 mm
Flange size for motor:	FT85
Connect code:	F
Liquid:	
Liquid temperature range:	-25 .. 120 °C
Electrical data:	
Motor type:	71A
Rated power - P2:	0.25 kW
Mains frequency:	50 Hz
Rated voltage:	3 x 220-255D/380-440Y V
Rated current:	1.12/0.65 A
Starting current:	570-620 %
Cos phi - power factor:	0.83-0.71
Rated speed:	2840-2880 rpm
IE Efficiency class:	IE3
Motor efficiency at full load:	77.5-77.2 %
Motor efficiency at 3/4 load:	76.8-74.5 %
Motor efficiency at 1/2 load:	72.7-68.4 %
Number of poles:	2
Enclosure class (IEC 34-5):	55 Dust/Jetting
Insulation class (IEC 85):	F
Built-in motor protection:	NONE
Motor No:	85105501
Controls:	
Frequency converter:	None
Others:	
Minimum efficiency index, MEI ≥:	0.60
Net weight:	19.9 kg

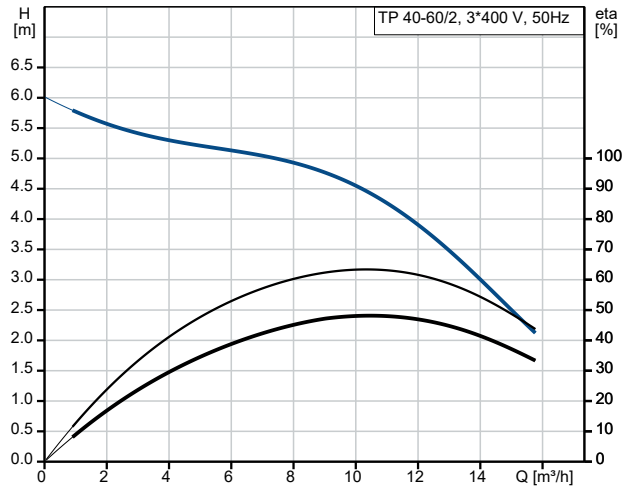

Pumped liquid = Water
Liquid temperature during operation = 20 °C
Density = 998.2 kg/m³

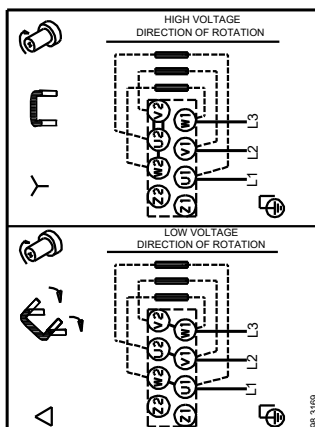
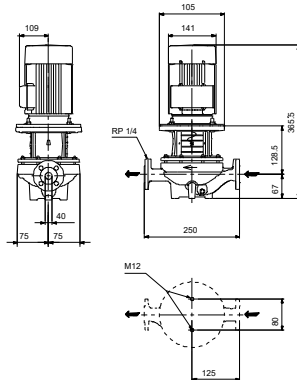
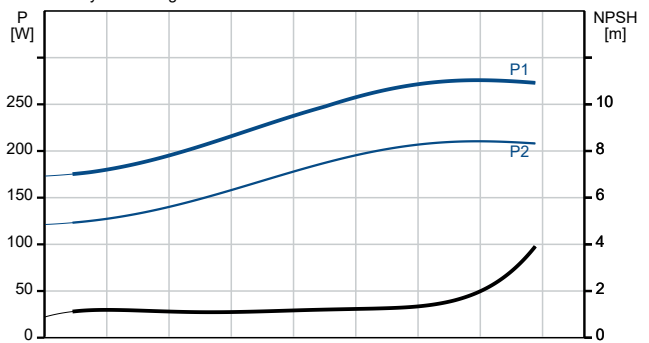



Company name:

Created by:

Phone:

Date:

30/11/2023

Description	Value
Gross weight:	23.4 kg
Shipping volume:	0.08 m ³
Finnish LVI No.:	4616025
Norwegian NRF no.:	9043539
Country of origin:	HU
Custom tariff no.:	84137051

On request TP 40-60/2 A-F-A-BQQE-CW1 50 Hz

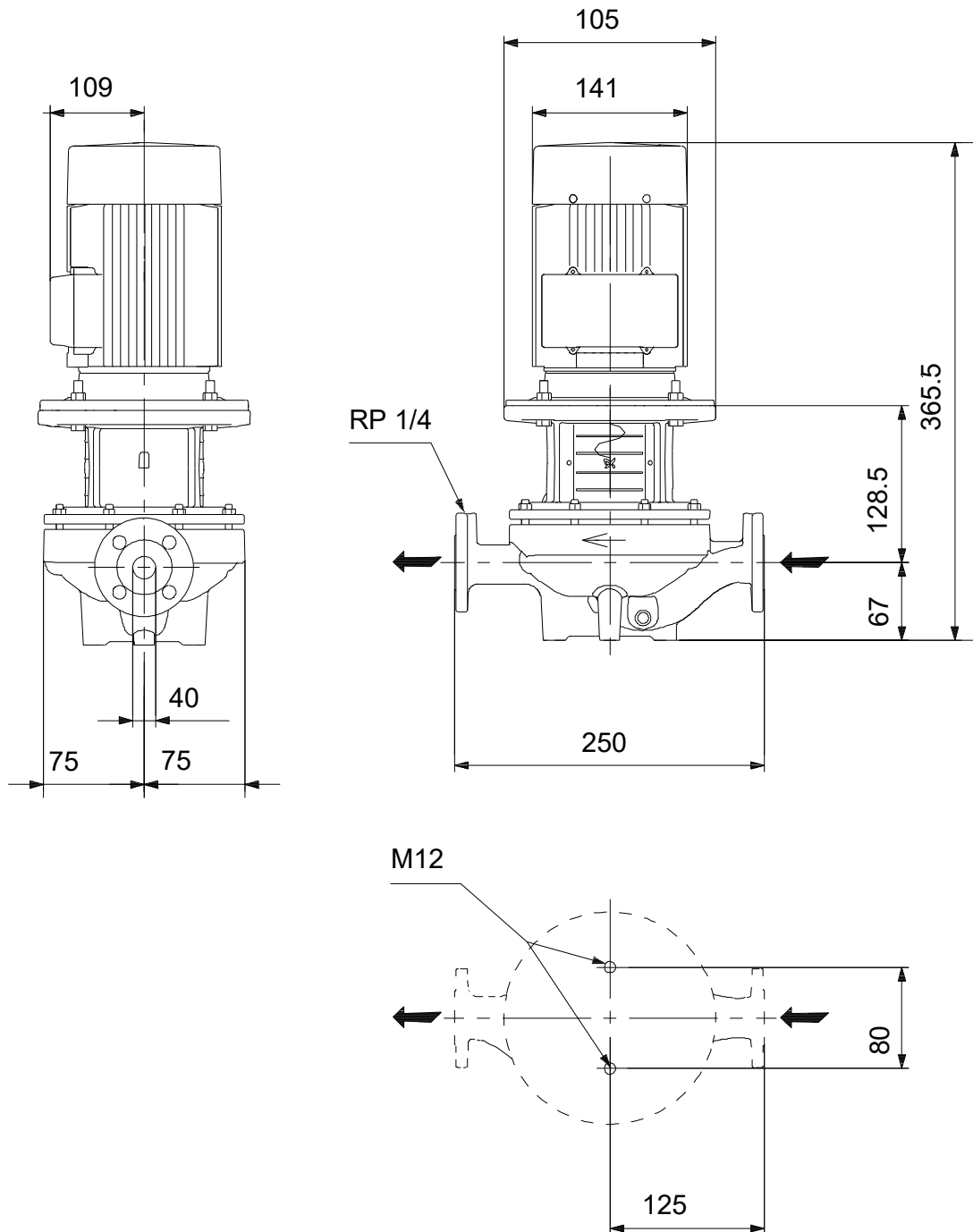

Note! All units are in [mm] unless others are stated.
Disclaimer: This simplified dimensional drawing does not show all details.

